

S P E C I F I C A T I O N S

SMD TYPE SIDE VIEW WHITE LED

Model : AS426TWPE1

Dongbu LED Co., Ltd.

90-1, Bongmyung-Ri, Namsa-Myun, Cheoin-Gu, Yongin-City, Gyeonggi-Do, Korea 449-882

Tel. : +82 - 70 - 7896 - 3600 Fax. : +82 - 31 - 339 - 7646

<http://www.dongbuled-s.com>

1. General Description

(1) Features

- Package Size - $2.8 \times 1.2 \times 0.8(t)$ mm
- White Emission Package (Side View)

(2) Applications

- Mobile phone , PDA , Indicator , Backlighting etc.

(3) Outline Dimensions

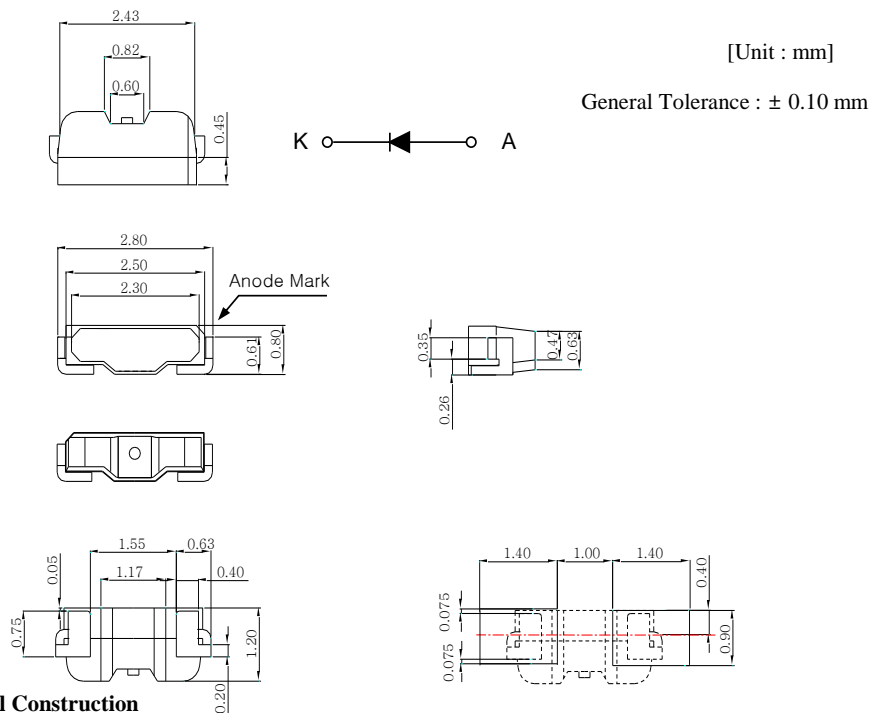

(4) Material Construction

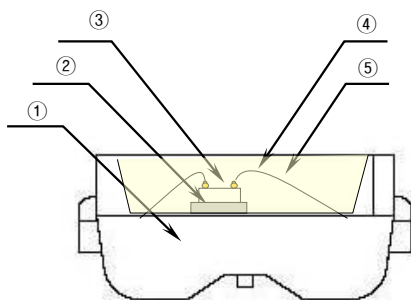

No.	Items	Material
①	Lead Frame	PPA
②	Paste	Resin
③	LED Chip	InGaN/Al ₂ O ₃
④	Gold Wire	Au
⑤	Mold Epoxy	Silicone + Phosphor

2. Specifications

(1) Absolute maximum ratings

Parameter	Symbol	Absolute maximum rating	Unit
Power Dissipation	P_D	102	mW
Forward Current	I_F	30	mA
Peak Pulse Current ⁽¹⁾	I_{FP}	100	mA
Operating Temperature	T_{OPR}	-30 to +85	°C
Storage Temperature	T_{STG}	-40 to +100	°C

Notes (1) Duty ratio = 1/10, pulse width = 10msec

* Noted Absolute Maximum Ratings are reference data

(Guarantee condition will be specified separately on request)

(2) Initial Electrical/Optical Characteristics

($T_a=25^\circ\text{C}$)

Parameter	Symbol	Condition	Min.	Typ.	Max.	Unit
Forward Voltage	V_F	$I_F = 20\text{mA}$	2.9	3.1	3.4	V
Reverse Current	I_R	$V_R = 5\text{V}$	-	-	10	μA
Luminous Intensity	I_V	$I_F = 20\text{mA}$	2,000	2,400	-	mcd
Chromaticity Coordinate ⁽¹⁾	Cx	$I_F = 20\text{mA}$	0.265	0.288	-	-
	Cy		0.231	0.278	-	-
Radiation Angle	$\Delta\theta$	$I_F = 20\text{mA}$	X - X : 120deg.			°
			Y - Y : 118deg.			

Notes (1) Please refer to CIE 1931 chromaticity diagram

* Initial Electrical/Optical Characteristics data could be changeable if the user use the product in different condition besides above data.

(3) Characteristics Rank

■ Forward voltage & Luminous intensity rank

($T_a=25^\circ\text{C}$)

Parameter	Symbol	Condition	Rank	Min.	Max.	Unit
Forward Voltage ⁽¹⁾	V_F	$I_F = 20\text{mA}$	V29	2.9	3.0	V
			V30	3.0	3.1	
			V31	3.1	3.2	
			V32	3.2	3.3	
			V33	3.3	3.4	
Luminous Intensity ⁽²⁾	I_V	$I_F = 20\text{mA}$	S20H	2,000	2,100	mcd
			S21H	2,100	2,200	
			S22H	2,200	2,300	
			S23H	2,300	2,400	
			S24H	2,400	2,500	
			S25H	2,500	2,600	
			S26H	2,600	2,700	
S27H	2,700	2,800				

Notes (1) Forward Voltage Measurement allowance is $\pm 10\%$.

(2) Luminous Intensity Measurement allowance is $\pm 10\%$

* Based on the measuring instruments of Dongbu LED

■ Color Rank

 (I_F=20mA, T_a=25℃)

	A1			
Cx	0.2600	0.2648	0.2685	0.2640
Cy	0.2460	0.2538	0.2495	0.2420

	A2			
Cx	0.2685	0.2640	0.2680	0.2723
Cy	0.2495	0.2420	0.2380	0.2453

	A3			
Cx	0.2680	0.2723	0.2760	0.2720
Cy	0.2380	0.2453	0.2410	0.2340

	A4			
Cx	0.2760	0.2720	0.2760	0.2798
Cy	0.2410	0.2340	0.2300	0.2368

	A5			
Cx	0.2760	0.2798	0.2835	0.2800
Cy	0.2300	0.2368	0.2325	0.2260

	B1			
Cx	0.2648	0.2695	0.2730	0.2685
Cy	0.2538	0.2615	0.2570	0.2495

	B2			
Cx	0.2730	0.2685	0.2723	0.2765
Cy	0.2570	0.2495	0.2453	0.2525

	B3			
Cx	0.2723	0.2765	0.2800	0.2760
Cy	0.2453	0.2525	0.2480	0.2410

	B4			
Cx	0.2800	0.2760	0.2798	0.2835
Cy	0.2480	0.2410	0.2368	0.2435

	B5			
Cx	0.2798	0.2835	0.2870	0.2835
Cy	0.2368	0.2435	0.2390	0.2325

	C1			
Cx	0.2695	0.2743	0.2775	0.2730
Cy	0.2615	0.2693	0.2645	0.2570

	C2			
Cx	0.2775	0.2730	0.2765	0.2808
Cy	0.2645	0.2570	0.2525	0.2598

	C3			
Cx	0.2765	0.2808	0.2840	0.2800
Cy	0.2525	0.2598	0.2550	0.2480

	C4			
Cx	0.2840	0.2800	0.2835	0.2873
Cy	0.2550	0.2480	0.2435	0.2503

	C5			
Cx	0.2835	0.2873	0.2905	0.2870
Cy	0.2435	0.2503	0.2455	0.2390

	D1			
Cx	0.2743	0.2790	0.2820	0.2775
Cy	0.2693	0.2770	0.2720	0.2645

	D2			
Cx	0.2820	0.2775	0.2808	0.2850
Cy	0.2720	0.2645	0.2598	0.2670

	D3			
Cx	0.2808	0.2850	0.2880	0.2840
Cy	0.2598	0.2670	0.2620	0.2550

	D4			
Cx	0.2880	0.2840	0.2873	0.2910
Cy	0.2620	0.2550	0.2503	0.2570

	D5			
Cx	0.2873	0.2910	0.2940	0.2905
Cy	0.2503	0.2570	0.2520	0.2455

	E1			
Cx	0.2790	0.2837	0.2865	0.2820
Cy	0.2770	0.2847	0.2795	0.2720

	E2			
Cx	0.2865	0.2820	0.2850	0.2893
Cy	0.2795	0.2720	0.2670	0.2743

	E3			
Cx	0.2850	0.2893	0.2920	0.2880
Cy	0.2670	0.2743	0.2690	0.2620

	E4			
Cx	0.2920	0.2880	0.2910	0.2948
Cy	0.2690	0.2620	0.2570	0.2638

	E5			
Cx	0.2910	0.2948	0.2975	0.2940
Cy	0.2570	0.2638	0.2585	0.2520

	F1			
Cx	0.2837	0.2885	0.2910	0.2865
Cy	0.2847	0.2925	0.2870	0.2795

	F2			
Cx	0.2910	0.2865	0.2893	0.2935
Cy	0.2870	0.2795	0.2743	0.2815

	F3			
Cx	0.2893	0.2935	0.2960	0.2920
Cy	0.2743	0.2815	0.2760	0.2690

	F4			
Cx	0.2960	0.2920	0.2948	0.2985
Cy	0.2760	0.2690	0.2638	0.2705

	F5			
Cx	0.2948	0.2985	0.3010	0.2975
Cy	0.2638	0.2705	0.2650	0.2585

	G1			
Cx	0.2885	0.2925	0.2950	0.2910
Cy	0.2925	0.2995	0.2940	0.2870

	G2			
Cx	0.2950	0.2910	0.2935	0.2975
Cy	0.2940	0.2870	0.2815	0.2885

	G3			
Cx	0.2935	0.2975	0.3000	0.2960
Cy	0.2815	0.2885	0.2830	0.2760

	G4			
Cx	0.3000	0.2960	0.2985	0.3025
Cy	0.2830	0.2760	0.2705	0.2775

	G5			
Cx	0.2985	0.3025	0.3050	0.3010
Cy	0.2705	0.2775	0.2720	0.2650

	H1			
Cx	0.2925	0.2965	0.2990	0.2950
Cy	0.2995	0.3065	0.3010	0.2940

	H2			
Cx	0.2990	0.2950	0.2975	0.3015
Cy	0.3010	0.2940	0.2885	0.2955

	H3			
Cx	0.2975	0.3015	0.3040	0.3000
Cy	0.2885	0.2955	0.2900	0.2830

	H4			
Cx	0.3040	0.3000	0.3025	0.3065
Cy	0.2900	0.2830	0.2775	0.2845

	H5			
Cx	0.3025	0.3065	0.3090	0.3050
Cy	0.2775	0.2845	0.2790	0.2720

	I1			
Cx	0.2965	0.3005	0.3030	0.2990
Cy	0.3065	0.3135	0.3080	0.3010

	I2			
Cx	0.3030	0.2990	0.3015	0.3055
Cy	0.3080	0.3010	0.2955	0.3025

	I3			
Cx	0.3015	0.3055	0.3080	0.3040
Cy	0.2955	0.3025	0.2970	0.2900

	I4			
Cx	0.3080	0.3040	0.3065	0.3105
Cy	0.2970	0.2900	0.2845	0.2915

	I5			
Cx	0.3065	0.3105	0.3130	0.3090
Cy	0.2845	0.2915	0.2860	0.2790

	J1			
Cx	0.3005	0.3045	0.3070	0.3030
Cy	0.3135	0.3205	0.3150	0.3080

	J2			
Cx	0.3070	0.3030	0.3055	0.3095
Cy	0.3150	0.3080	0.3025	0.3095

	J3			
Cx	0.3055	0.3095	0.3120	0.3080
Cy	0.3025	0.3095	0.3040	0.2970

	J4			
Cx	0.3120	0.3080	0.3105	0.3145
Cy	0.3040	0.2970	0.2915	0.2985

	J5			
Cx	0.3105	0.3145	0.3170	0.3130
Cy	0.2915	0.2985	0.2930	0.2860

	K1			
Cx	0.3045	0.3085	0.3110	0.3070
Cy	0.3205	0.3275	0.3220	0.3150

	K2			
Cx	0.3070	0.3110	0.3135	0.3095
Cy	0.3150	0.3220	0.3165	0.3095

	K3			
Cx	0.3095	0.3135	0.3160	0.3120
Cy	0.3095	0.3165	0.3110	0.3040

	K4			
Cx	0.3120	0.3160	0.3185	0.3145
Cy	0.3040	0.3110	0.3055	0.2985

	K5			
Cx	0.3145	0.3185	0.3210	0.3170
Cy	0.2985	0.3055	0.3000	0.2930

	L1			
Cx	0.3085	0.3125	0.3150	0.3110
Cy	0.3275	0.3345	0.3290	0.3220

	L2			
Cx	0.3110	0.3150	0.3175	0.3135
Cy	0.3220	0.3290	0.3235	0.3165

	L3			
Cx	0.3135	0.3175	0.3200	0.3160
Cy	0.3165	0.3235	0.3180	0.3100

	L4			
Cx	0.3160	0.3200	0.3225	0.3185
Cy	0.3110	0.3180	0.3125	0.3055

	L5			
Cx	0.3185	0.3225	0.3250	0.3210
Cy	0.3055	0.3125	0.3070	0.3000

Notes (1) Chromaticity coordinates measurement allowance is ± 0.01 .

(Based on the measuring instruments of Dongbu LED)

(2) The Chromaticity coordinates refer to CIE 1931 chromaticity diagram.

■ Chromaticity Diagram

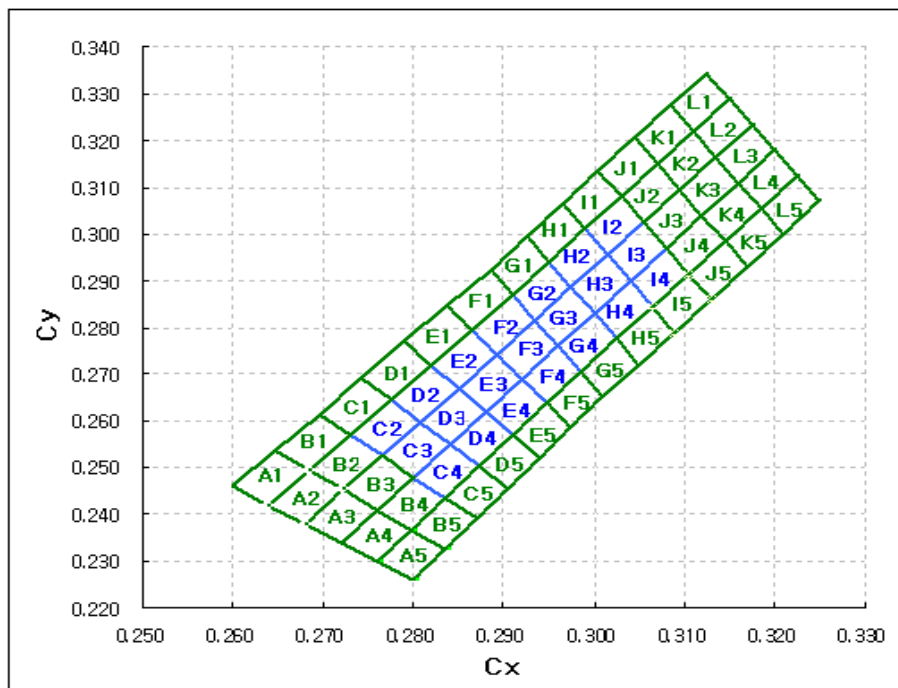

3. Rank

* The rank inscription is composed of the follow method.

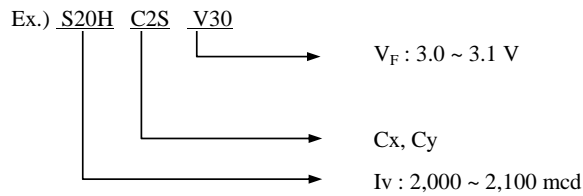

- S : Used 4 rank in one rank
- D : Used 2 vertical rank in one rank
- R : Used 2 horizontal rank in one rank

- ※ Ex) C2S = C2,C3,D2,D3
- C2D = C2,C3
- C2R = C2,D2

4. Characteristics Diagrams

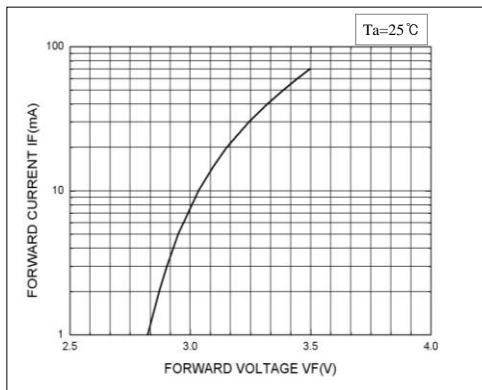

Forward Current vs Forward Voltage

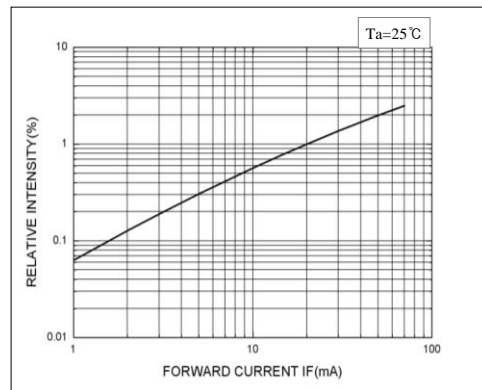

Relative Luminous Intensity vs Forward Current

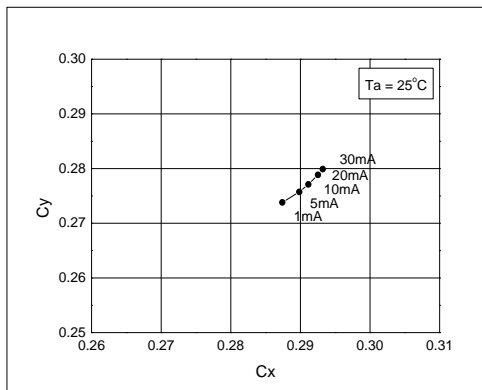

Forward Current vs Chromaticity Diagram

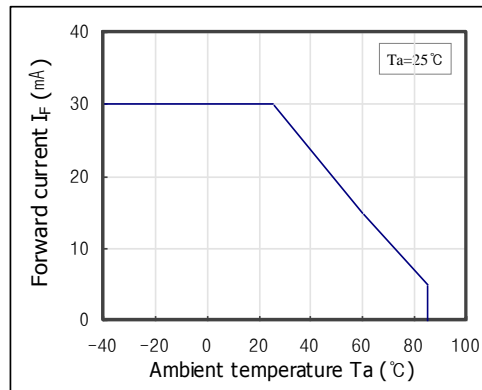

Forward Current Dissipation Curve

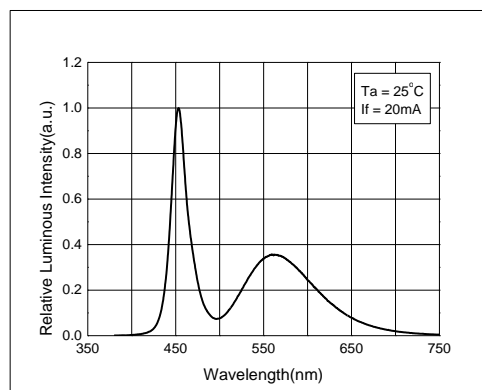

Relative Spectral Emission

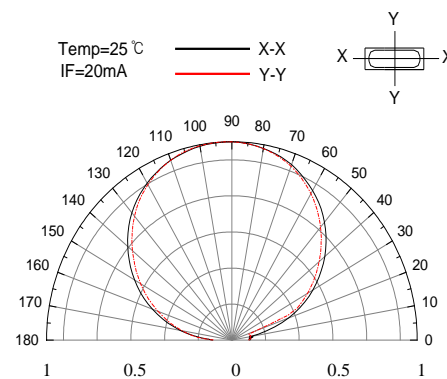

Radiation Angle

* The graph of characteristics is the sampling data for the reference.

5. Results of Reliability Tests
(1) Test Items and Results

Item	Test Condition	Notes	No. of Damaged
Temperature Cycle	-40℃ ~25℃ ~100℃ ~25℃ (30min~5min~30min~5min)	100Cycle	0/50
Steady State Operating Life	$T_a = 25^\circ\text{C}$, $I_F = 20\text{mA}$	1000hrs	0/50
Steady State Operating Life of High Temperature	$T_a = 85^\circ\text{C}$, $I_F = 5\text{mA}$	1000hrs	0/50
Steady State Operating Life of High Humidity Heat	$T_a = 60^\circ\text{C}$, RH = 90%, $I_F = 15\text{mA}$	1000hrs	0/50
Steady State Operating Life of Low Temperature	$T_a = -30^\circ\text{C}$, $I_F = 20\text{mA}$	1000hrs	0/50
High Temperature Storage	$T_a = 100^\circ\text{C}$	1000hrs	0/50
High Temperature & Humidity Storage	$T_a = 60^\circ\text{C}$, RH = 90%	1000hrs	0/50
Low Temperature Storage	$T_a = -40^\circ\text{C}$	1000hrs	0/50
Resistance to Soldering Heat	$T_{\text{max}}=260^\circ\text{C}$, 10sec (Pre treatment 30°C , 70%, 168hrs)	2 time	0/50

* The above reliability data is only for the reference data about the environment test.

(2) Criteria for Judging the Damage

Parameter	Symbol	Condition	Criteria for Judgement	
			Min.	Max.
Forward Voltage	V_F	$I_F = 20\text{mA}$	-	U.S.L. ⁽¹⁾ * 1.2
Luminous Intensity	I_v	$I_F = 20\text{mA}$	L.S.L. ⁽²⁾ * 0.7	-

Notes (1) U.S.L. : Upper Specification Level

(2) L.S.L. : Lower Specification Level

6. Soldering Conditions

(1) Recommended Soldering Conditions

Reflow Soldering			Hand Soldering	
	Lead Solder	Lead-Free Solder	Temperature Soldering time	300°C Max. 3 sec. Max. (one time only)
Pre-Heating	120 ~ 150 °C	180 ~ 200 °C		
Pre-Heat Time	120sec. Max.	120sec. Max.		
Peak Temperature	240 °C Max.	260 °C Max.		
Soldering Time	5sec. Max.	5sec. Max.		

* After reflow soldering, Rapid cooling should be avoid.

(2) Recommended Reflow Soldering profile

■ Lead Solder

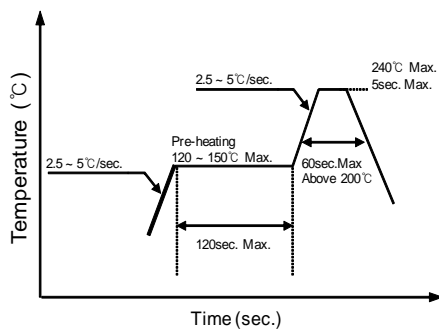

■ Lead-Free Solder

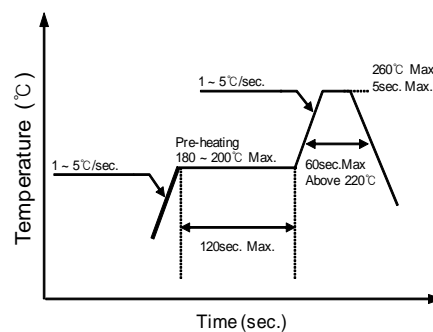

(3) Recommended Soldering Pattern

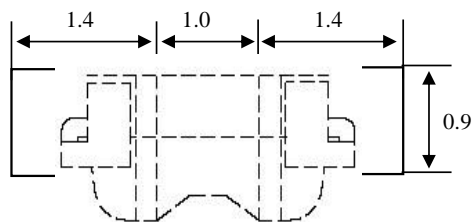

(Unit : mm)

(4) Soldering Cautions

- Reflow soldering should not be done more than two times.
- When soldering, do not put stress on the LEDs during heating.
- After soldering, do not wrap the circuit board.
- The LEDs can be soldered on place using the reflow soldering method.
- Occasionally there is a brightness decrease cause by the influence of heat or ambient atmosphere during air reflow. It is recommend that the user use the nitrogen reflow method.
- After complete soldering, the product should be handled after cooling. (required to be handled under 60 °C)

7. Packing

(1) Carrier Tape & Carrier Reel Dimensions

■ Carrier Tape

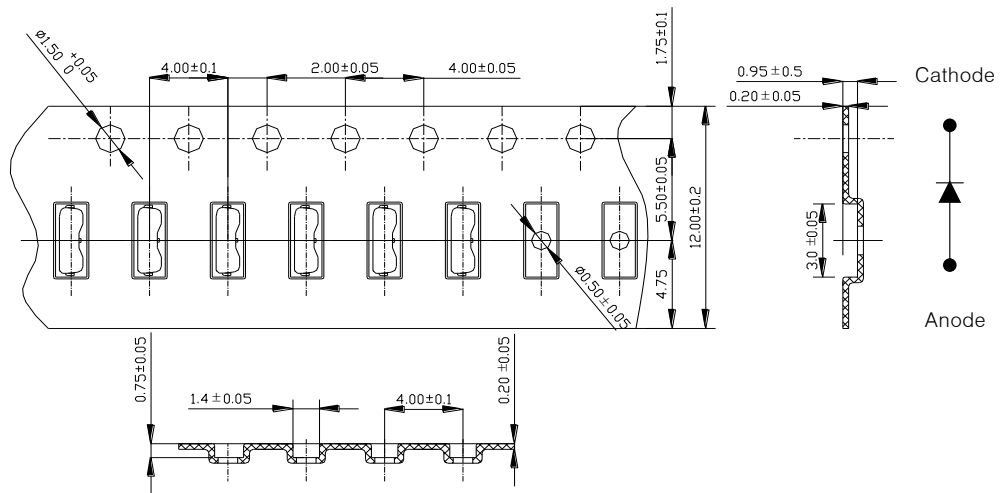

■ Carrier Reel

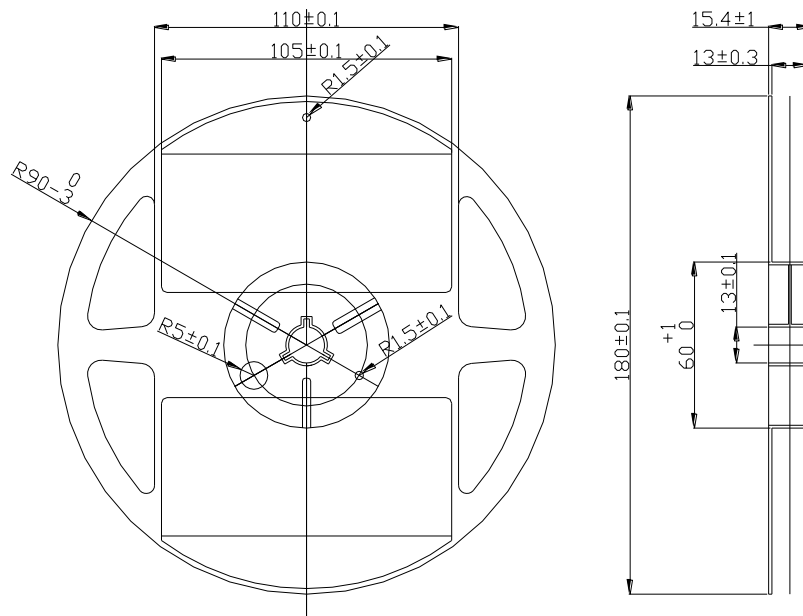

Notes

- (1) Quantity : Taping of 1 reel will be from 1,000 pcs to 5,000 pcs in unit of a number in the thousands.
- (2) Adhesion strength of cover tape is 0.1 ~ 0.7N(20gf ~60gf) when the cover tape is turned off from the carrier tape.

(2) Packing and Packaging

■ Label



■ Reel

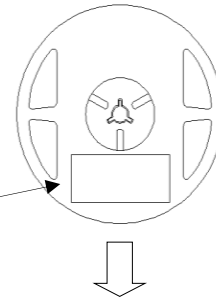

■ Aluminium bag

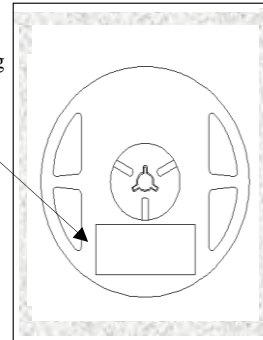

■ Inner Box

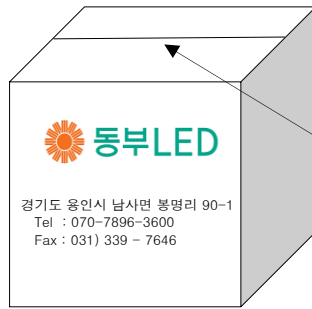

■ Box label

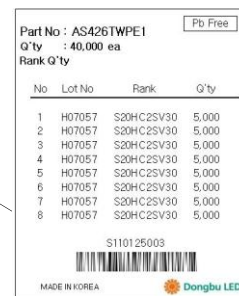

■ Outer Box

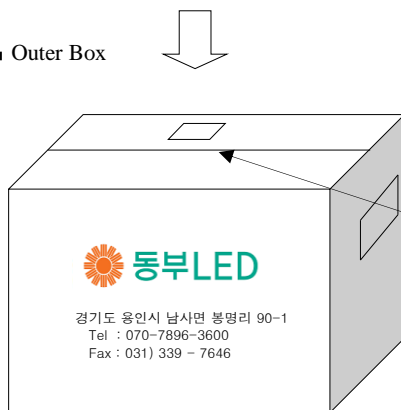

Box Type	Inner Box	Outer Box	
		Medium	Large
Max. Packing Q'ty(pcs)	40,000	160,000	320,000

(1) The carrier tape wound on the Reel are placed into an ESD protected pack with a silicagel and sealed by the thermal pressure sealer. Then this sealed pack is packaged in a cardboard box.

8. Precaution

(1) Static Electricity

These LEDs are highly susceptible to static electricity or surge voltage. So a wrist strap or an anti-electrostatic glove necessarily be used when handling the LEDs. Do not use the equipment that surge voltage is came into existence.

All devices and equipment that measure or mount the LEDs must be properly grounded.

After being assembled LEDs, it should be ascertained a electrical characteristic whether that are damaged by static electricity or not. It is easy to find the damaged LEDs by a light-on or VF test at forward a below 0.15mA current.

(2) Packing

The moisture that is absorbed into the LED products may cause a badness and damage to the optical characteristics of the LEDs. Therefore the moisture barrier aluminum bag is used to keep moisture in the packing. And a silicagel is inserted into a moisture barrier aluminum bag that sealed by the thermal pressure sealer.

(3) Cleaning

We greatly recommend IPA(solution) for LED cleaning and it should be limited exposure time for cleaning maximum 1 minute. (We can not guarantee the quality assurance if it has been used to other solution.)

It is recommended that isopropyl alcohol(IPA) be used as a solvent for cleaning the LEDs.

Do not clean the LEDs by the ultrasonic. When it use other solvents or is absolutely necessary ultrasonic, before cleaning, a pre-test should be done to confirm whether the LEDs are any damaged or not

(4) Storage

In order to avoid the absorption of moisture, it is recommended to store LEDs in the moisture barrier aluminum bag is not opened.

Storage condition before opening the packing :

Temperature : below 30℃

Humidity : 90%RH max

The LEDs should be used within a year.

Storage condition after opening the packing :

Temperature : below 30℃

Humidity : 60%RH max

The products have to be used within one year from the date marked on label which is attached to reel or aluminium bag.

After opening the packing, the LEDs should be used within 168 hours(7days). If unused LEDs remain, they should be stored in the place kept away moisture.

If the LEDs have exceeded the above storage time, it should be used after to bake using the following conditions.

Baking condition : 60±5℃, more than 24 hours

(5) Pick and Place

It should be avoided to rub or scratch the surface of resin by any hard material. It is possible that the LEDs are damaged to the optical characteristics.

(6) Heat

The LEDs are products that are generated heat. Please consider the heat generation of the LED when it is designed the PCB. After considering the ambient temperature and the heat generation of LEDs, the operating current should be decided

(7) Others

If the forward or reverse voltage which exceeds the absolute maximum rating is applied to the LEDs, that will cause the damage to the LEDs. It is possible that the damaged LEDs do not light on at the low current.

Be careful not to look the LEDs that the output power is strongly increased in the face. It is possible that eyesight has been getting weaker.

This specifications of the product may be revised without notice.

Light emitting part should not be exposed by physical contact. It can be the reason of material desquamation and progressive disconnection.

This LED is made for in-door use only. If the user wants the LED for out-door use, it is necessary to take some additional treatment on the product after surface mounting technology(SMT).

This specification could be changed without a notice to the customer because of the inside circumstance of the company.