

SPECIFICATIONS

SMD TYPE TOP VIEW WHITE LED
MODEL : AT724TWPNQ

Dongbu LED Co., Ltd.
53-24 , Dongtansandan 6-gil , Hwaseong-si , Gyeonggi-do , Republic of Korea 18487
Tel. : +82 - 70 - 8874 - 9943 Fax. : +82 - 31 - 373 - 7626
[http : //www.dongbuled-s.com](http://www.dongbuled-s.com)

1. General Description

(1) Features

- Package size - 7.0(L) × 2.0(W) × 0.65(T) mm
- Wide beam angle ($2\theta_{1/2}=120\text{deg}$)
- RoHS Compliant

(2) Applications

- Backlighting (LCD, switches, keys, displays)
- Coupling into light guides
- Optical indicator
- General lighting

(3) Outline Dimensions

[Tolerance : ± 0.1 , unit : mm]

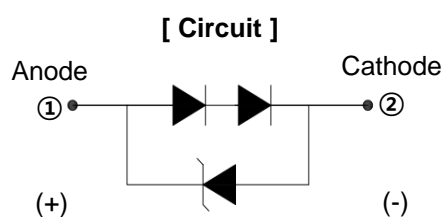
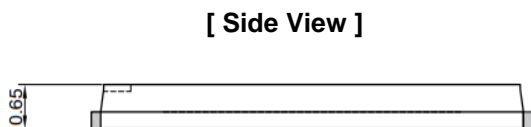
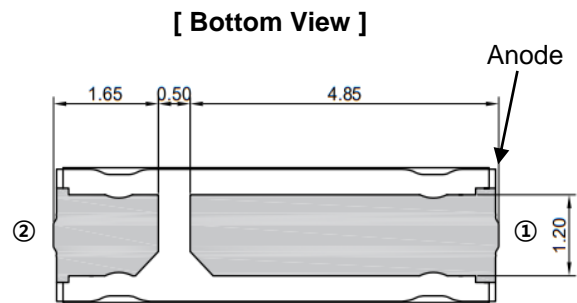
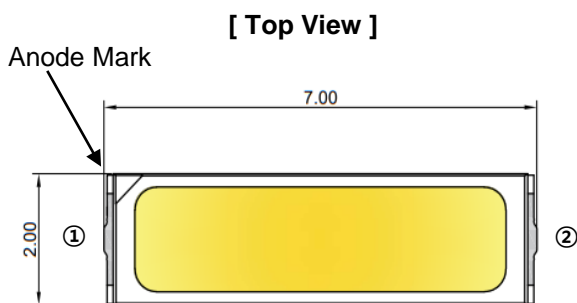

2. Specifications

(1) Absolute Maximum Ratings

 (T_a=25°C)

Parameter	Symbol	Absolute Maximum Rating	Unit	Remark
Power Dissipation	P _D	1188	mW	
Forward Current	I _F	180	mA	
Peak Pulse Current ⁽¹⁾	I _{FP}	350	mA	
Operating Temperature	T _{OPR}	-40 to +85	°C	
Storage Temperature	T _{STG}	-40 to +100	°C	

* Note : (1) Duty ratio = 1/10, pulse width = 10msec

(2) Initial Electrical/Optical Characteristics

 (T_a=25°C)

Parameter	Symbol	Condition	Min.	Typ.	Max.	Unit
Forward Voltage	V _F	I _F = 120mA	5.8	-	6.6	V
Luminous Intensity	I _V	I _F = 120mA	26	-	38	cd
Reverse Voltage	V _R	I _R = 5mA	0.7	-	1.2	V
Beam Angle	2θ _½	I _F = 120mA	-	120	-	deg
Chromaticity Coordinate	C _x	I _F = 120mA	-	0.2785	-	-
	C _y		-	0.2590	-	-

* Note : Initial electrical/optical characteristics data could be changeable if the user use the product in different condition besides above data.

(3) Characteristics Rank

■ Forward Voltage & Luminous Intensity Rank

 (T_a=25°C)

Parameter	Symbol	Condition	Rank	Min.	Max.	Unit
Forward Voltage ⁽¹⁾	V _F	I _F = 120mA	X58	5.8	6.0	V
			X60	6.0	6.2	
			X62	6.2	6.4	
			X64	6.4	6.6	
Luminous Intensity ⁽²⁾	I _V	I _F = 120mA	B26	26	28	cd
			B28	28	30	
			B30	30	32	
			B32	32	34	
			B34	34	36	
			B36	36	38	

* Notes : (1) Forward voltage measurement tolerance is ± 0.2V.

(2) Luminous intensity measurement tolerance is ± 7%.

Based on the measuring instruments of Dongbu LED

■ Color Rank

($I_F = 120\text{mA}$, $T_a = 25^\circ\text{C}$)

Rank	A00				Rank	B00			
Cx	0.2688	0.2638	0.2538	0.2588	Cx	0.2738	0.2688	0.2588	0.2638
Cy	0.2094	0.1994	0.1994	0.2094	Cy	0.2194	0.2094	0.2094	0.2194

Rank	C00				Rank	D00			
Cx	0.2788	0.2738	0.2638	0.2688	Cx	0.2838	0.2788	0.2688	0.2738
Cy	0.2294	0.2194	0.2194	0.2294	Cy	0.2394	0.2294	0.2294	0.2394

Rank	E00				Rank	F00			
Cx	0.2888	0.2838	0.2738	0.2788	Cx	0.2938	0.2888	0.2788	0.2838
Cy	0.2494	0.2394	0.2394	0.2494	Cy	0.2594	0.2494	0.2494	0.2594

Rank	G00				Rank	H00			
Cx	0.2988	0.2938	0.2838	0.2888	Cx	0.3038	0.2988	0.2888	0.2938
Cy	0.2694	0.2594	0.2594	0.2694	Cy	0.2794	0.2694	0.2694	0.2794

Rank	I00				Rank	J00			
Cx	0.3088	0.3038	0.2938	0.2988	Cx	0.3138	0.3088	0.2988	0.3038
Cy	0.2894	0.2794	0.2794	0.2894	Cy	0.2994	0.2894	0.2894	0.2994

Rank	K00				Rank	L00			
Cx	0.3188	0.3138	0.3038	0.3088	Cx	0.3238	0.3188	0.3088	0.3138
Cy	0.3094	0.2994	0.2994	0.3094	Cy	0.3194	0.3094	0.3094	0.3194

Rank	A01				Rank	B01			
Cx	0.2588	0.2538	0.2438	0.2488	Cx	0.2638	0.2588	0.2488	0.2538
Cy	0.2094	0.1994	0.1994	0.2094	Cy	0.2194	0.2094	0.2094	0.2194

Rank	C01				Rank	D01			
Cx	0.2688	0.2638	0.2538	0.2588	Cx	0.2738	0.2688	0.2588	0.2638
Cy	0.2294	0.2194	0.2194	0.2294	Cy	0.2394	0.2294	0.2294	0.2394

Rank	E01				Rank	F01			
Cx	0.2788	0.2738	0.2638	0.2688	Cx	0.2838	0.2788	0.2688	0.2738
Cy	0.2494	0.2394	0.2394	0.2494	Cy	0.2594	0.2494	0.2494	0.2594

Rank	G01				Rank	H01			
Cx	0.2888	0.2838	0.2738	0.2788	Cx	0.2938	0.2888	0.2788	0.2838
Cy	0.2694	0.2594	0.2594	0.2694	Cy	0.2794	0.2694	0.2694	0.2794

■ Color Rank

($I_F = 120\text{mA}$, $T_a = 25^\circ\text{C}$)

Rank	I01				Rank	J01			
Cx	0.2988	0.2938	0.2838	0.2888	Cx	0.3038	0.2988	0.2888	0.2938
Cy	0.2894	0.2794	0.2794	0.2894	Cy	0.2994	0.2894	0.2894	0.2994

Rank	K01				Rank	L01			
Cx	0.3088	0.3038	0.2938	0.2988	Cx	0.3138	0.3088	0.2988	0.3038
Cy	0.3094	0.2994	0.2994	0.3094	Cy	0.3194	0.3094	0.3094	0.3194

Rank	A02				Rank	B02			
Cx	0.2488	0.2438	0.2338	0.2388	Cx	0.2538	0.2488	0.2388	0.2438
Cy	0.2094	0.1994	0.1994	0.2094	Cy	0.2194	0.2094	0.2094	0.2194

Rank	C02				Rank	D02			
Cx	0.2588	0.2538	0.2438	0.2488	Cx	0.2638	0.2588	0.2488	0.2538
Cy	0.2294	0.2194	0.2194	0.2294	Cy	0.2394	0.2294	0.2294	0.2394

Rank	E02				Rank	F02			
Cx	0.2688	0.2638	0.2538	0.2588	Cx	0.2738	0.2688	0.2588	0.2638
Cy	0.2494	0.2394	0.2394	0.2494	Cy	0.2594	0.2494	0.2494	0.2594

Rank	G02				Rank	H02			
Cx	0.2788	0.2738	0.2638	0.2688	Cx	0.2838	0.2788	0.2688	0.2738
Cy	0.2694	0.2594	0.2594	0.2694	Cy	0.2794	0.2694	0.2694	0.2794

Rank	I02				Rank	J02			
Cx	0.2888	0.2838	0.2738	0.2788	Cx	0.2938	0.2888	0.2788	0.2838
Cy	0.2894	0.2794	0.2794	0.2894	Cy	0.2994	0.2894	0.2894	0.2994

Rank	K02				Rank	L02			
Cx	0.2988	0.2938	0.2838	0.2888	Cx	0.3038	0.2988	0.2888	0.2938
Cy	0.3094	0.2994	0.2994	0.3094	Cy	0.3194	0.3094	0.3094	0.3194

* Notes : (1) Chromaticity coordinates measurement tolerance is ± 0.01 .

Based on the measuring instruments of Dongbu LED

(2) The Chromaticity coordinates refer to CIE 1931 chromaticity diagram.

■ CIE Chromaticity Diagram

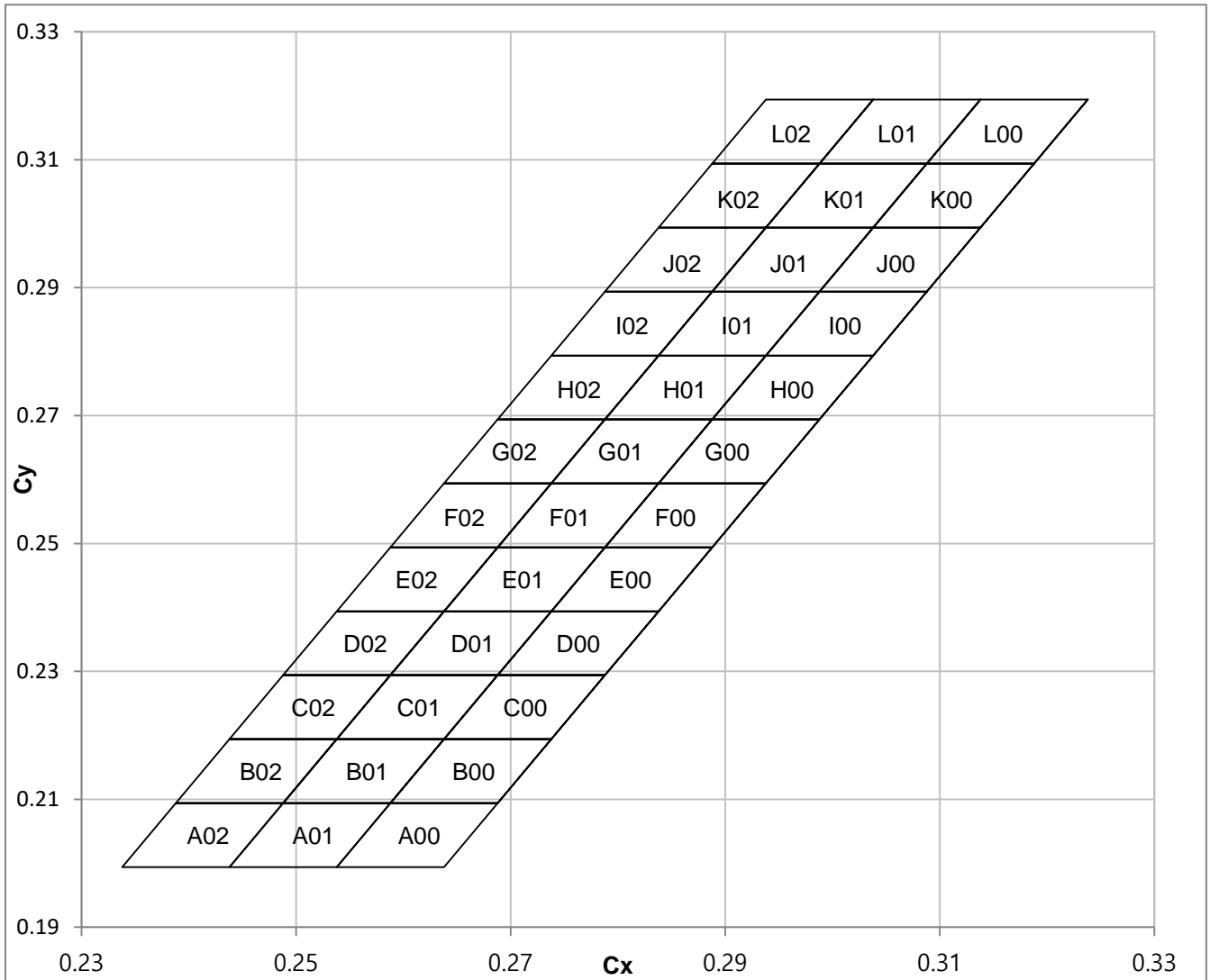

3. Rank Code

The rank inscription is composed of the follow method.

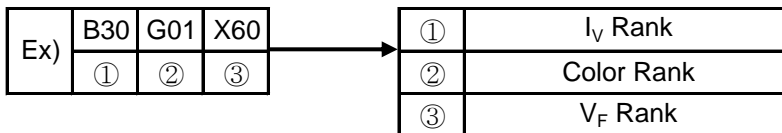

4. Characteristics Diagrams

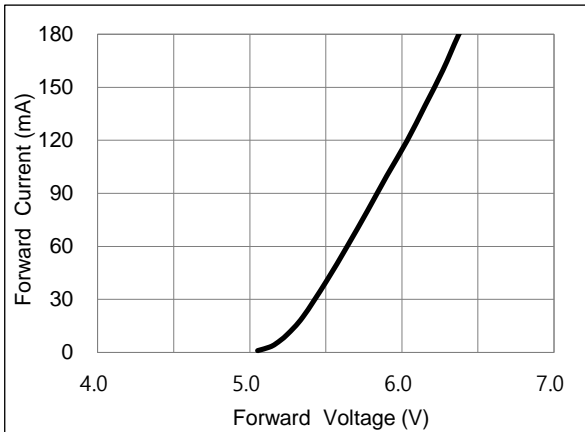

Forward Voltage vs Forward Current, $T_a=25^\circ\text{C}$

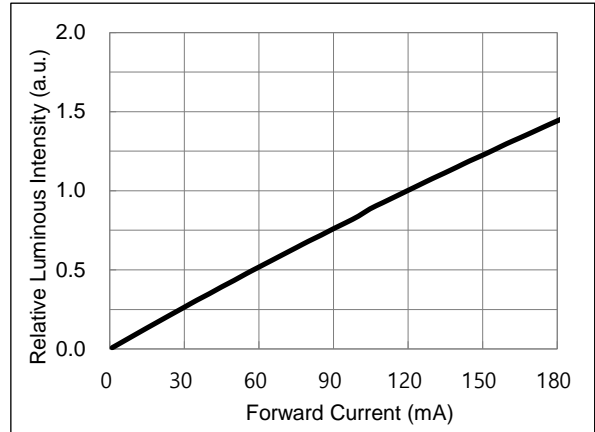

Forward Current vs Relative Luminous Intensity, $T_a=25^\circ\text{C}$

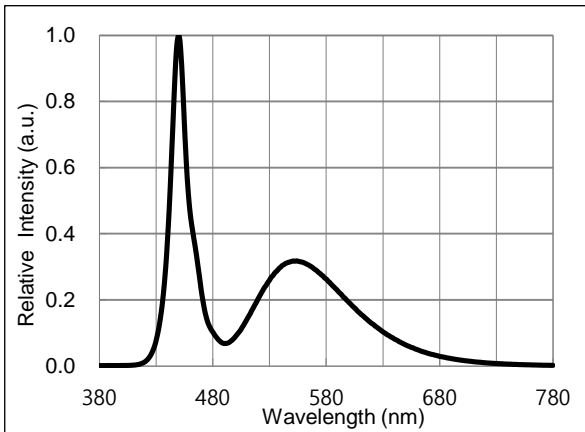

Spectrum, $T_a=25^\circ\text{C}$, $I_F=120\text{mA}$

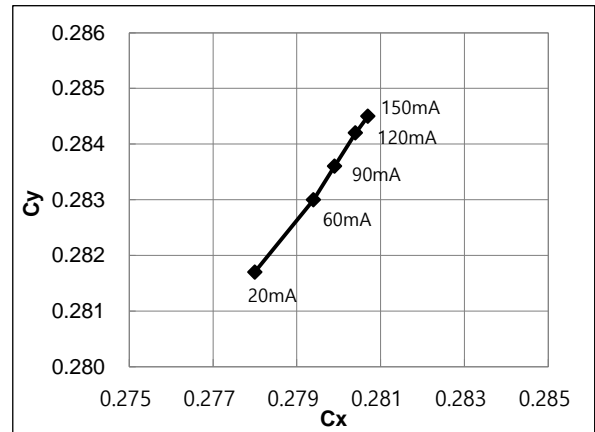

Forward Current vs Chromaticity Coordinate, $T_a=25^\circ\text{C}$

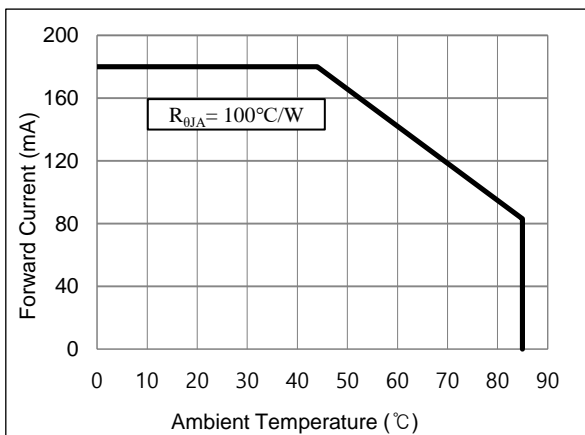

Derating Curve

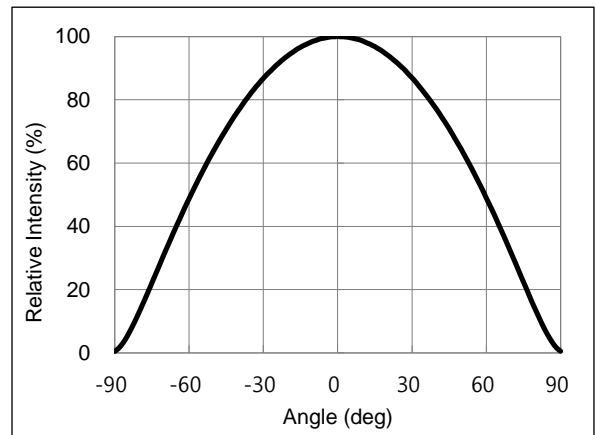

Beam Angle, $T_a=25^\circ\text{C}$, $I_F=120\text{mA}$

* Note : The graph of characteristics is the sampling data for the reference.

5. Soldering Conditions

(1) Recommended Soldering Conditions

Conditions	Reflow Soldering		Hand Soldering	
	Lead Solder	Lead-Free Solder		
Pre-Heating	120 ~ 150 °C	180 ~ 200 °C	Temperature Soldering time	300 °C Max. 3 sec. Max. (one time only)
Pre-Heat Time	120sec. Max.	120sec. Max.		
Peak Temperature	240 °C Max.	260 °C Max.		
Soldering Time	5sec. Max.	5sec. Max.		

* After reflow soldering, rapid cooling should be avoid.

(2) Recommended Reflow Soldering Profile

■ Lead Solder

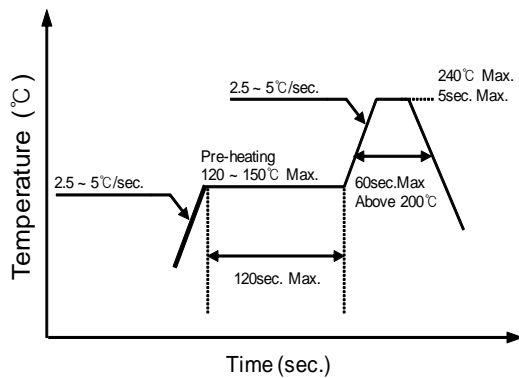

■ Lead Free Solder

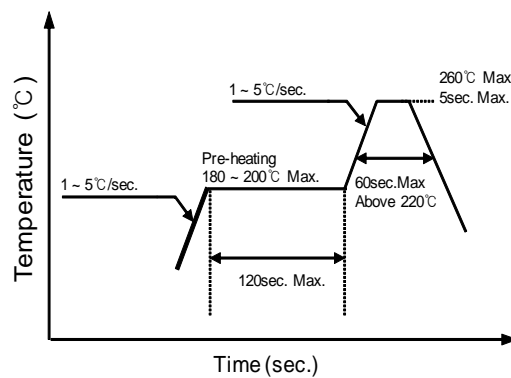

(3) Recommended Soldering Pad Pattern

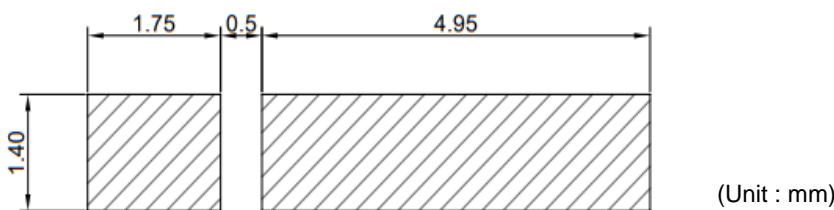

(4) Soldering Cautions

- Reflow soldering should not be done more than two times.
- When soldering, do not put stress on the LEDs during heating.
- After soldering, do not wrap the circuit board.
- The LEDs can be soldered on place using the reflow soldering method.
- Occasionally there is a brightness decrease cause by the influence of heat or ambient atmosphere during air reflow. It is recommend that the user use the nitrogen reflow method.
- After complete soldering, the product should be handled after cooling. (required to be handled under 60 °C)

6. Packing

(1) Carrier Tape & Carrier Reel Dimensions

■ Carrier Tape

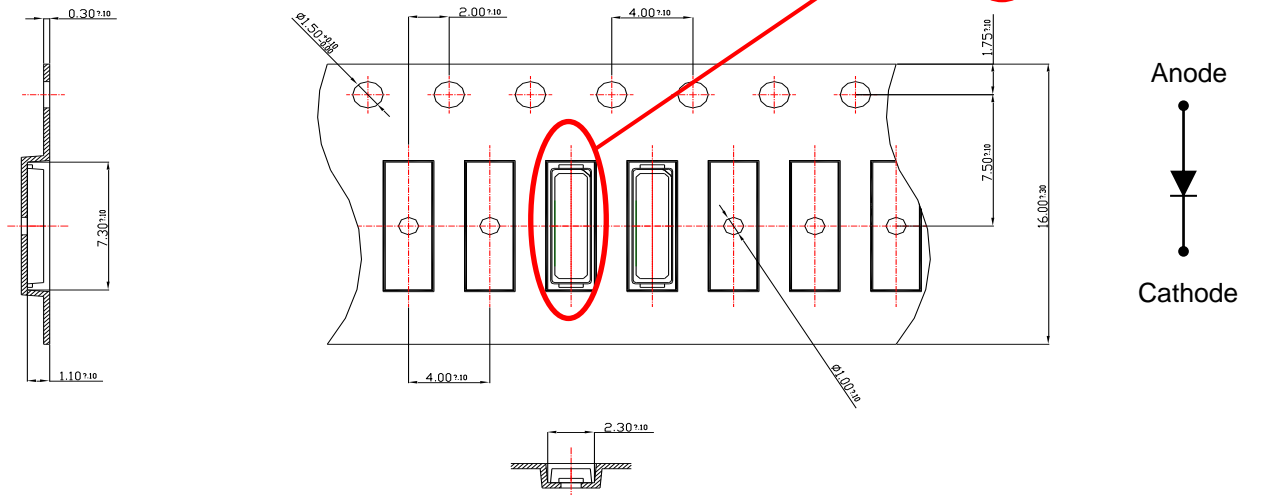

■ Carrier Reel

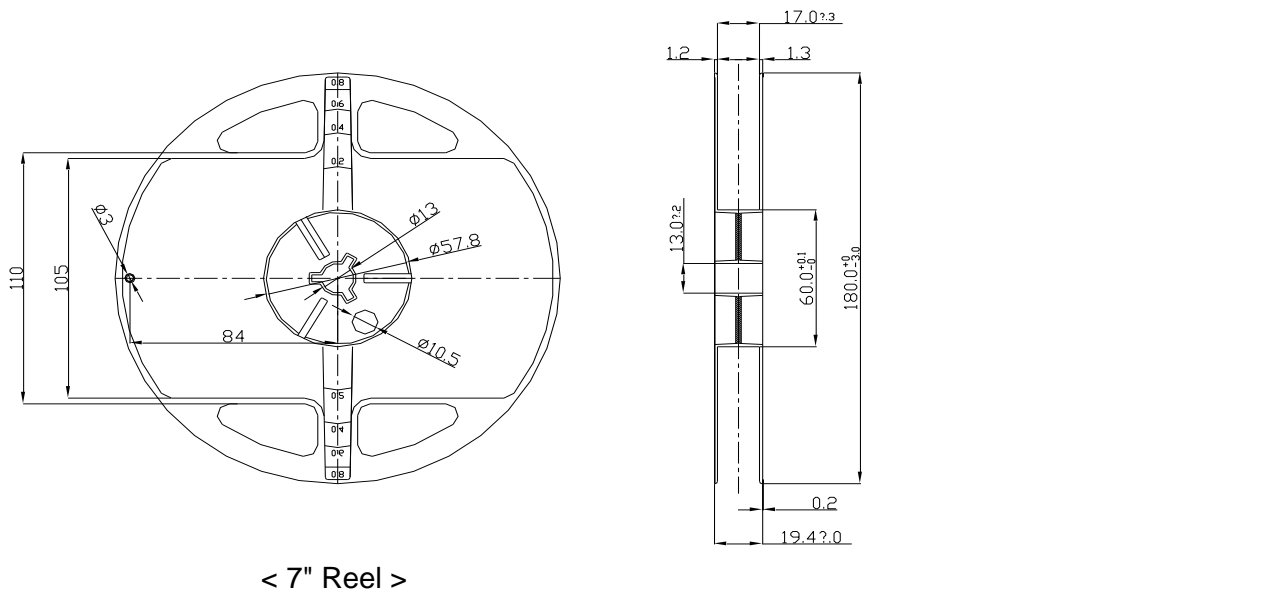

- 1) Quantity : Taping of 1 reel will be from min 1,000pcs to 3,000pcs in unit of a number in the thousands.
- 2) Adhesion strength of cover tape is 0.1 ~ 0.7N(20gf ~60gf) when the cover tape is turned off from the carrier tape.

(2) Packing and Packaging

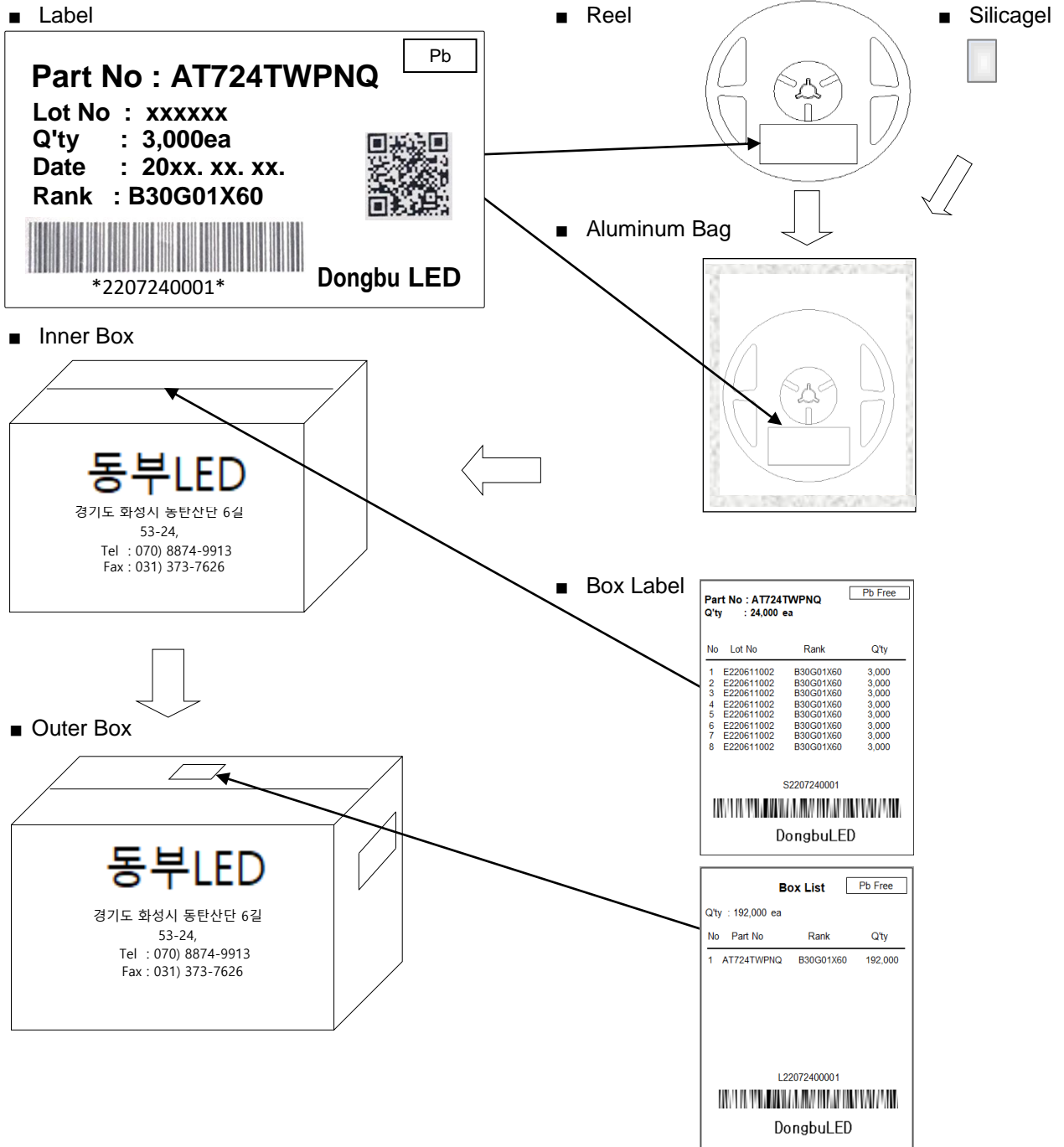

Box Type	Inner Box	Outer Box	
		Medium	Large
Max. Packing Q'ty(pcs)	24,000	96,000	192,000

1) The carrier tape winded on the reel are placed into an ESD protected pack with a silicagel and sealed by the thermal pressure sealer. Then this sealed pack is packaged in a cardboard box.

7. Precaution

(1) Static Electricity

These LEDs are highly susceptible to static electricity or surge voltage. So a wrist strap or an anti-electrostatic glove necessarily be used when handling the LEDs.

Do not use the equipment that surge voltage is came into existence.

All devices and equipment that measure or mount the LEDs must be properly grounded.

After being assembled LEDs, it should be ascertained a electrical characteristic whether that are damaged by static electricity or not.

(2) Packing

The moisture that is absorbed into the LED products may cause a badness and damage to the optical characteristics of the LEDs. Therefore the moisture barrier aluminum bag is used to keep moisture in the packing. And a silicagel is inserted into a moisture barrier aluminum bag that sealed by the thermal pressure sealer.

(3) Cleaning

Ethanol can be used for LED cleaning. The maximum exposure time with ethanol is 1 minute for cleaning.

Do not use ultrasonic for cleaning the LEDs or other solvents, If ultrasonic cleaning is absolutely necessary, a pre-test should be done before cleaning to see if the LED is damaged.

(4) Storage

In order to avoid the absorption of moisture, it is recommended to store LEDs in the moisture barrier aluminum bag is not opened.

Storage condition before opening the packing :

Temperature : below 30℃

Humidity : 90%RH max

The LEDs should be used within a year.

Storage condition after opening the packing :

Temperature : below 30℃

Humidity : 60%RH max

The products have to be used within one year from the date marked on label which is attached to reel or aluminium bag. After opening the packing, the LEDs should be used within 168 hours(7days). If unused LEDs remain, they should be stored in the place kept away moisture.

If the LEDs have exceeded the above storage time, it should be used after to bake using the following conditions.

Baking condition : 60±5℃, 10 ~ 24 hours

A slight amount of sulfur, chlorine or VOC from the surrounding environment may cause discoloration of the LEDs.

(5) Pick and Place

It should be avoided to rub or scratch the surface of resin by any hard material. It is possible that the LEDs are damaged to the optical characteristics.

(6) Heat

The LEDs are products that are generated heat. It must be considered the heat generation of the LEDs when it is designed the PCB. After considering the ambient temperature and the heat generation of LEDs, the operating current should be decided .

(7) Others

If the forward or reverse voltage which exceeds the absolute maximum rating is applied to the LEDs, that will cause the damage to the LEDs. It is possible that the damaged LEDs do not light on at the current.

Be careful not to look the LEDs that the output power is strongly increased in the face. It is possible that eyesight has been getting weaker.

Light emitting part should not be exposed by physical contact. It can be the reason of material desquamation and progressive disconnection.

This LED is made for in-door use only. If the user wants the LED for out-door use, it is necessary to take some additional treatment on the product after surface mounting technology(SMT).

This specification could be changed without a notice to the customer because of the inside circumstance of the company.