

# PRELIMINARY SPECIFICATIONS

**SMD TYPE TOP VIEW WHITE LED**

**MODEL : AT732□W□NQ**

Donbu LED Co., Ltd.

90-1, Bongmyung-Ri, Namsa-Myun, Cheoin-Gu, Yongin-City, Gyeonggi-Do, Korea 449-882

Tel. : +82 - 70 - 7896 - 3600 Fax. : +82 - 31 - 339 - 7646

## 1. General Description

### (1) Features

- Package Size - 7.0(L) × 3.0(W) × 0.85(T) mm
- Ideal for backlighting and coupling in light guides
- Wide view angle ( $2\theta_{1/2}=120\text{deg.}$ )

### (2) Applications

- Backlighting(LCD, switches, keys, displays)
- Coupling into light guides
- Optical indicator
- Interior automotive lighting

### (3) Outline Dimensions

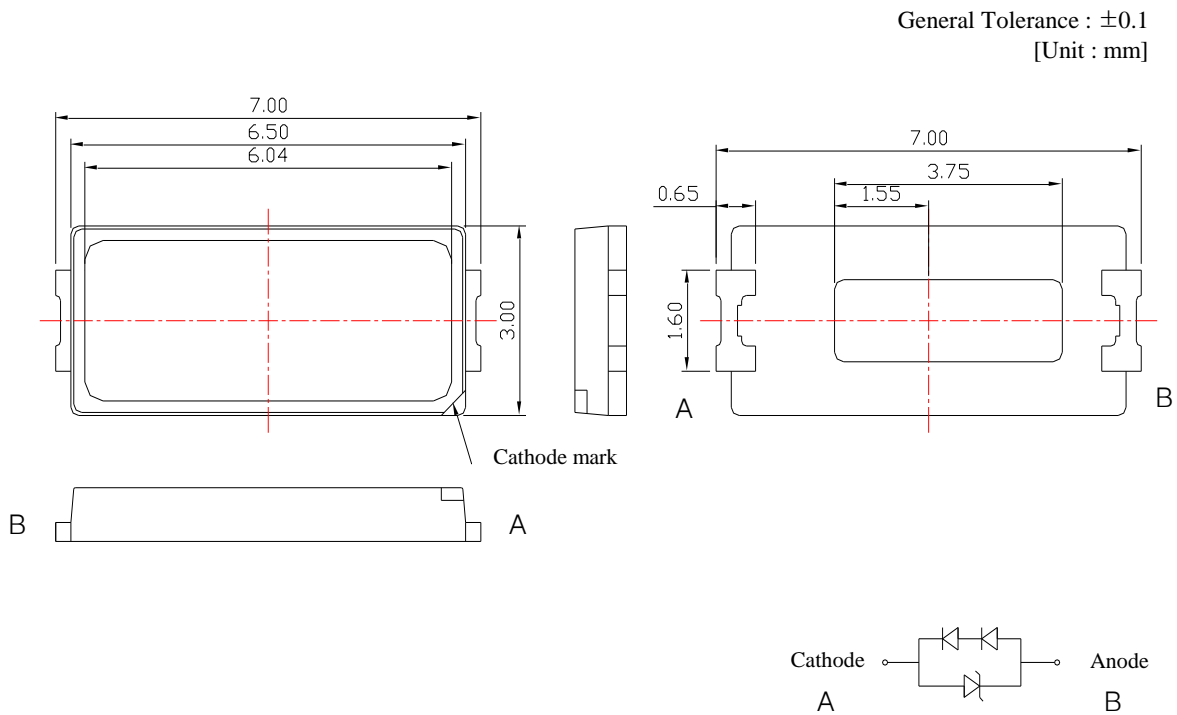

## 2. Specifications

### (1) Absolute maximum ratings (T<sub>a</sub>=25℃)

Parameter	Symbol	Absolute maximum rating	Unit	Remark
Power Dissipation	P <sub>D</sub>	620	mW	
Forward Current	I <sub>F</sub>	100	mA	
Reverse Voltage	V <sub>R</sub>	5	V	I <sub>R</sub> =5μA
Operating Temperature	T <sub>OPR</sub>	-30 to +85	℃	
Storage Temperature	T <sub>STG</sub>	-40 to +100	℃	

\* Noted Absolute Maximum Ratings are reference data.

(Guarantee condition will be specified separately on request)

### (2) Initial Electrical/Optical Characteristics (T<sub>a</sub>=25℃)

Parameter	Symbol	Condition	Min.	Typ.	Max.	Unit
Forward Voltage	V <sub>F</sub>	I <sub>F</sub> = 70mA	5.6	5.8	6.2	V
Reverse Current	I <sub>R</sub>	V <sub>R</sub> = 5V	-	-	10	μA
Luminous Intensity	I <sub>V</sub>	I <sub>F</sub> = 70mA	18.0	-	23.0	cd
Luminous Flux <sup>(1)</sup>	Φ <sub>V</sub>	I <sub>F</sub> = 70mA	58	-	74	lm
Color Rendering Index <sup>(2)</sup>	CRI	I <sub>F</sub> = 70mA	80.0	-		Ra

Notes (1) Only reference data.

(2) Color Rendering Index Measurement allowance is ± 3.

\* Initial Electrical/Optical Characteristics data could be changeable if the user use the product in different condition besides above data.

### (3) Characteristics Rank

#### ■ Forward voltage & Luminous intensity rank (T<sub>a</sub>=25℃)

Parameter	Symbol	Condition	Rank	Min.	Max.	Unit
Forward Voltage <sup>(1)</sup>	V <sub>F</sub>	I <sub>F</sub> =70mA	X56	5.6	5.8	V
			X58	5.8	6.0	
			X60	6.0	6.2	
Luminous Intensity <sup>(2)</sup>	I <sub>V</sub>	I <sub>F</sub> =70mA	SH18	18.0	19.0	cd
			SH19	19.0	20.0	
			SH20	20.0	21.0	
			SH21	21.0	22.0	
			SH22	22.0	23.0	

Notes (1) Forward Voltage Measurement allowance is ± 10

(2) Luminous Intensity Measurement allowance is ± 10%

(Based on the measuring instruments of Dongbu LED)

## ■ Color Rank

 (at  $I_F=70\text{mA}$ ,  $T_a=25^\circ\text{C}$ )

	7A			
C <sub>x</sub>	0.3028	0.3116	0.3140	0.3055
C <sub>y</sub>	0.3374	0.3462	0.3330	0.3250

	7B			
C <sub>x</sub>	0.3055	0.3140	0.3158	0.3077
C <sub>y</sub>	0.3250	0.3330	0.3215	0.3145

	6A			
C <sub>x</sub>	0.3116	0.3205	0.3215	0.3140
C <sub>y</sub>	0.3462	0.3547	0.3410	0.3330

	6B			
C <sub>x</sub>	0.3140	0.3215	0.3225	0.3158
C <sub>y</sub>	0.3330	0.3410	0.3275	0.3215

	6C			
C <sub>x</sub>	0.3205	0.3290	0.3292	0.3215
C <sub>y</sub>	0.3547	0.3615	0.3480	0.3410

	6D			
C <sub>x</sub>	0.3215	0.3292	0.3295	0.3225
C <sub>y</sub>	0.3410	0.3480	0.3335	0.3275

	5A			
C <sub>x</sub>	0.3290	0.3376	0.3370	0.3292
C <sub>y</sub>	0.3615	0.3686	0.3550	0.3480

	5B			
C <sub>x</sub>	0.3292	0.3370	0.3362	0.3295
C <sub>y</sub>	0.3480	0.3550	0.3392	0.3335

	5C			
C <sub>x</sub>	0.3376	0.3463	0.3450	0.3370
C <sub>y</sub>	0.3686	0.3758	0.3610	0.3550

	5D			
C <sub>x</sub>	0.3370	0.3450	0.3438	0.3362
C <sub>y</sub>	0.3550	0.3610	0.3455	0.3392

	5E			
C <sub>x</sub>	0.3463	0.3550	0.3530	0.3450
C <sub>y</sub>	0.3758	0.3830	0.3660	0.3610

	5F			
C <sub>x</sub>	0.3450	0.3530	0.3508	0.3438
C <sub>y</sub>	0.3610	0.3660	0.3520	0.3455

	4A			
C <sub>x</sub>	0.3551	0.3643	0.3620	0.3530
C <sub>y</sub>	0.3830	0.3890	0.3730	0.3660

	4B			
C <sub>x</sub>	0.3530	0.3620	0.3600	0.3508
C <sub>y</sub>	0.3660	0.3730	0.3590	0.3520

	4C			
C <sub>x</sub>	0.3643	0.3755	0.3720	0.3620
C <sub>y</sub>	0.3890	0.3960	0.3800	0.3730

	4D			
C <sub>x</sub>	0.3620	0.3720	0.3680	0.3600
C <sub>y</sub>	0.3730	0.3800	0.3640	0.3590

	4E			
C <sub>x</sub>	0.3755	0.3871	0.3828	0.3720
C <sub>y</sub>	0.3960	0.4030	0.3870	0.3800

	4F			
C <sub>x</sub>	0.3720	0.3828	0.3780	0.3680
C <sub>y</sub>	0.3800	0.3870	0.3695	0.3640

	4G			
C <sub>x</sub>	0.3871	0.4006	0.3950	0.3828
C <sub>y</sub>	0.4030	0.4110	0.3950	0.3870

	4H			
C <sub>x</sub>	0.3828	0.3950	0.3889	0.3780
C <sub>y</sub>	0.3870	0.3950	0.3760	0.3695

	3A			
C <sub>x</sub>	0.4006	0.4150	0.4095	0.3950
C <sub>y</sub>	0.4110	0.4170	0.4005	0.3950

	3B			
C <sub>x</sub>	0.3950	0.4095	0.4018	0.3889
C <sub>y</sub>	0.3950	0.4005	0.3822	0.3760

	3C			
C <sub>x</sub>	0.4150	0.4299	0.4223	0.4095
C <sub>y</sub>	0.4170	0.4235	0.4059	0.4005

	3D			
C <sub>x</sub>	0.4095	0.4223	0.4147	0.4018
C <sub>y</sub>	0.4005	0.4059	0.3884	0.3822

	3E			
C <sub>x</sub>	0.4299	0.4431	0.4345	0.4223
C <sub>y</sub>	0.4235	0.4283	0.4105	0.4059

	3F			
C <sub>x</sub>	0.4223	0.4345	0.4260	0.4147
C <sub>y</sub>	0.4059	0.4105	0.3924	0.3884

	3G			
C <sub>x</sub>	0.4431	0.4562	0.4467	0.4345
C <sub>y</sub>	0.4283	0.4330	0.4147	0.4105

	3H			
C <sub>x</sub>	0.4345	0.4467	0.4373	0.4260
C <sub>y</sub>	0.4105	0.4147	0.3963	0.3924

	2A			
C <sub>x</sub>	0.4562	0.4688	0.4590	0.4467
C <sub>y</sub>	0.4330	0.4360	0.4180	0.4147

	2B			
C <sub>x</sub>	0.4467	0.4590	0.4483	0.4373
C <sub>y</sub>	0.4147	0.4180	0.3988	0.3963

	2C			
C <sub>x</sub>	0.4688	0.4813	0.4709	0.4590
C <sub>y</sub>	0.4360	0.4389	0.4210	0.4180

	2D			
C <sub>x</sub>	0.4590	0.4709	0.4593	0.4483
C <sub>y</sub>	0.4180	0.4210	0.4014	0.3988

Notes (1) Chromaticity coordinates measurement allowance is  $\pm 0.01$ .

(Based on the measuring instruments of Dongbu LED)

(2) The Chromaticity coordinates refer to CIE 1931 chromaticity diagram.

■ Chromaticity Diagram

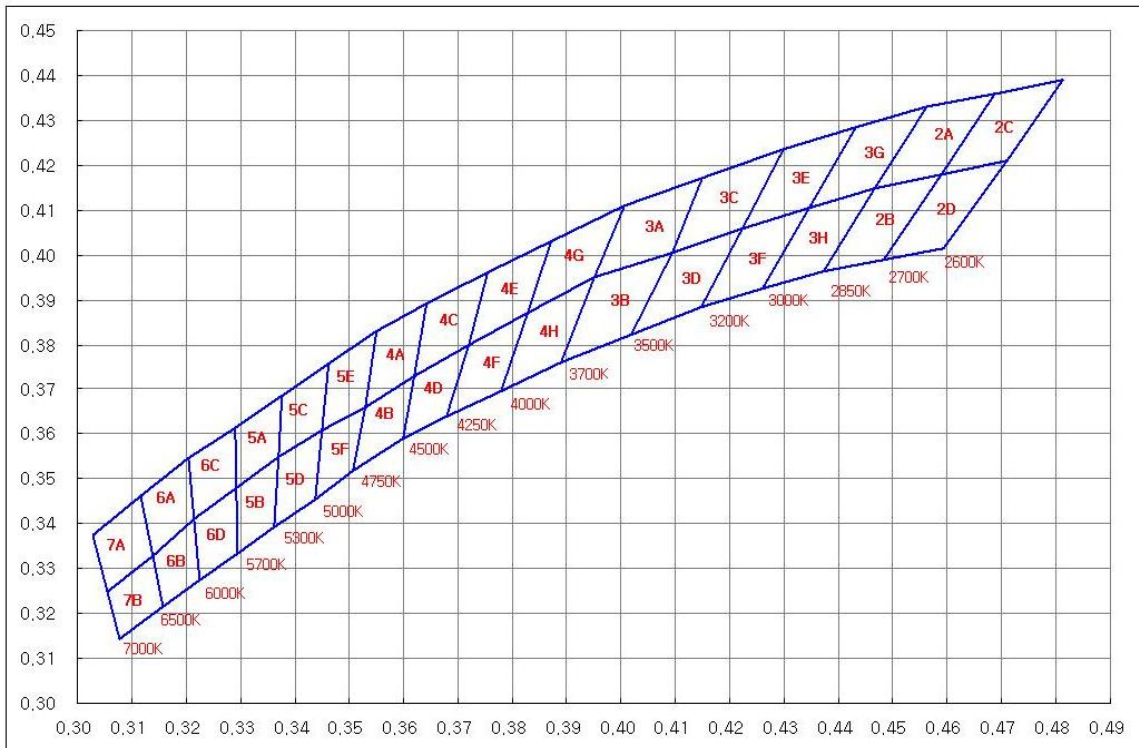

3. Rank

The rank inscription is composed of the follow method.

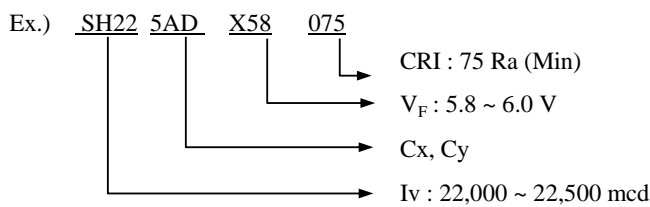

- S : Used 4 rank in one rank
- D : Used 2 vertical rank in one rank
- R : Used 2 horizontal rank in one rank

- ※ Ex) 5AS = 5A,5B,5C,5D
- 5AD = 5A,5B
- 5AR = 5A,5C

4. Characteristics Diagrams

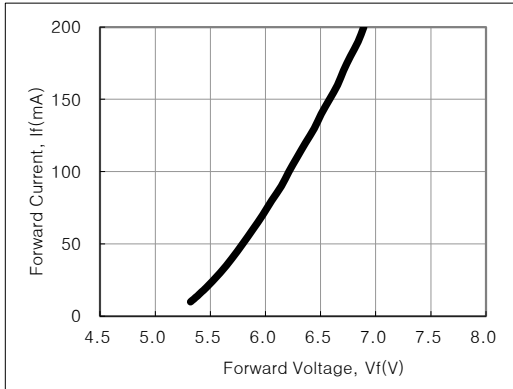

Forward Current vs Forward Voltage

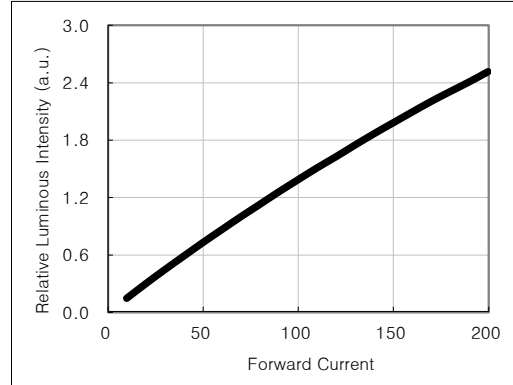

Relative Luminous Intensity vs Forward Current

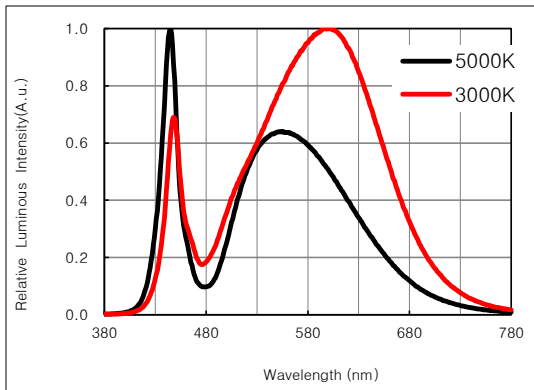

Relative Spectral Emission

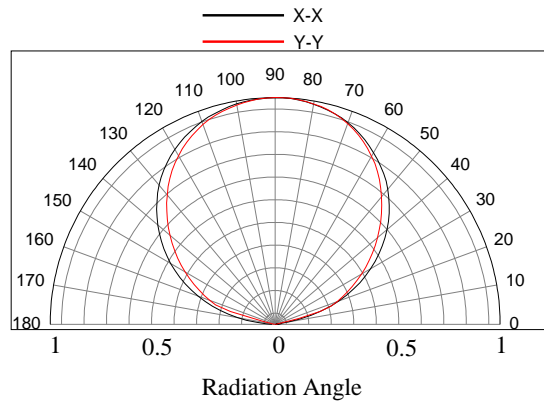

Radiation Angle

\* The graph of characteristics is the sampling data for the reference.

5. Soldering Conditions

(1) Recommended Soldering Conditions

Reflow Soldering			Hand Soldering	
	Lead Solder	Lead-Free Solder	Temperature Soldering time	300℃ Max. 3 sec. Max. (one time only)
Pre-Heating	120 ~ 150℃	180 ~ 200℃		
Pre-Heat Time	120sec. Max.	120sec. Max.		
Peak Temperature	240℃ Max.	260℃ Max.		
Soldering Time	5sec. Max.	5sec. Max.		

\* After reflow soldering, Rapid cooling should be avoided.

(2) Recommended Reflow Soldering profile

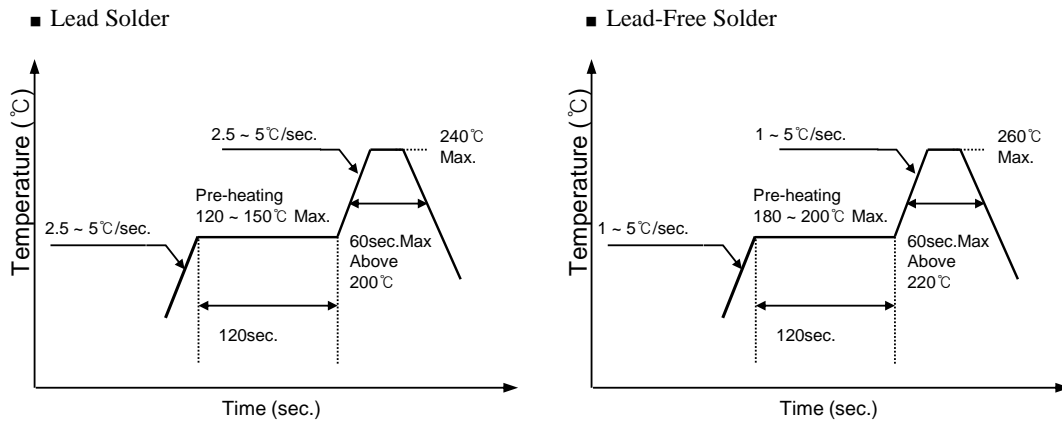

(3) Recommended Soldering Pattern

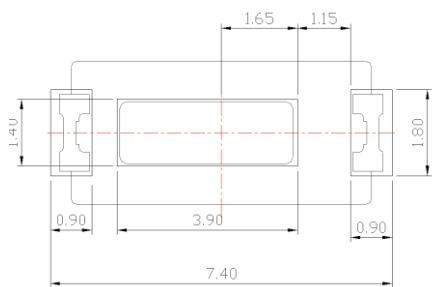

(Unit : mm)

(4) Soldering Cautions

- Reflow soldering should not be done more than two times.
- When soldering, do not put stress on the LEDs during heating.
- After soldering, do not wrap the circuit board.
- The LEDs can be soldered on place using the reflow soldering method.
- Occasionally there is a brightness decrease cause by the influence of heat or ambient atmosphere during air reflow. It is recommend that the user use the nitrogen reflow method.
- After complete soldering, the product should be handled after cooling. (required to be handled under 60℃)



## 6. Packing

### (1) Carrier Tape & Carrier Reel Dimensions

#### ■ Carrier Tape

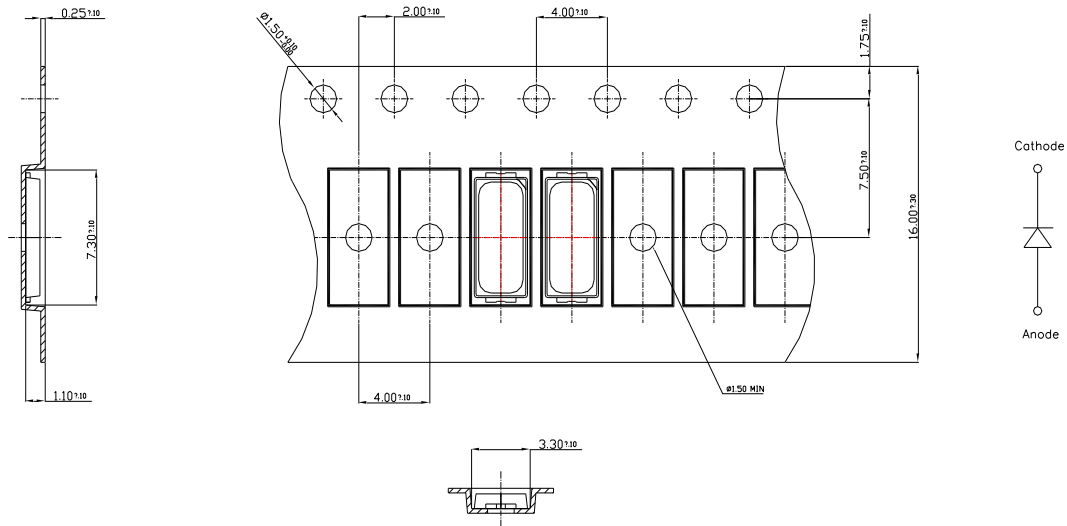

#### ■ Carrier Reel

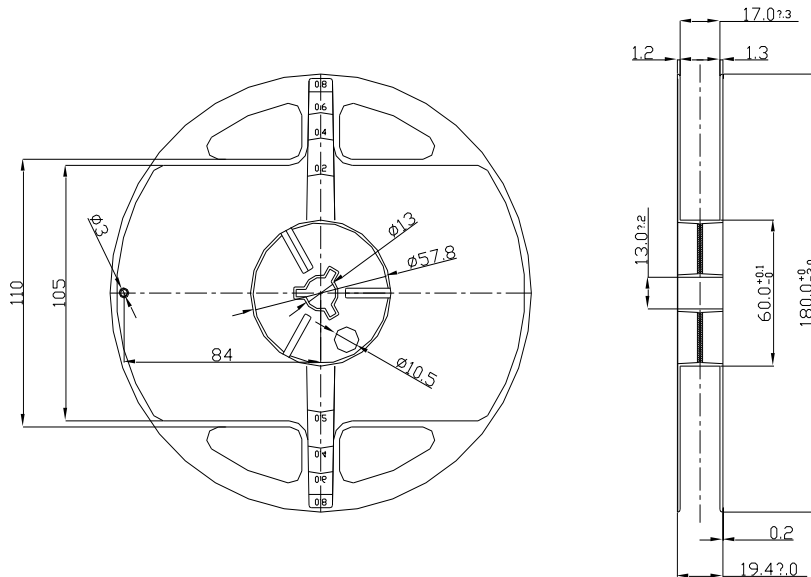

Notes (1) Quantity : 1,000pcs/reel

(2) Adhesion strength of cover tape is 0.1 ~ 0.7N when the cover tape is turned off from the carrier tape.

(2) Packing and Packaging

Label

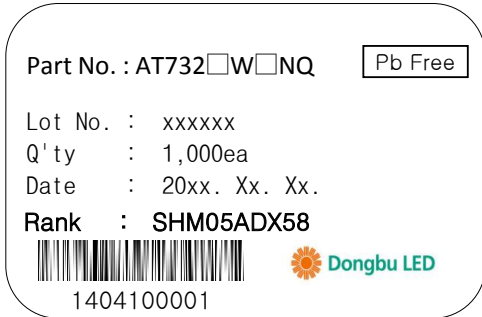

Reel

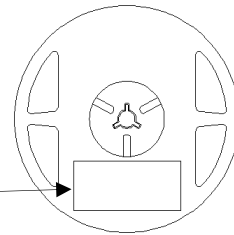

Aluminum Bag

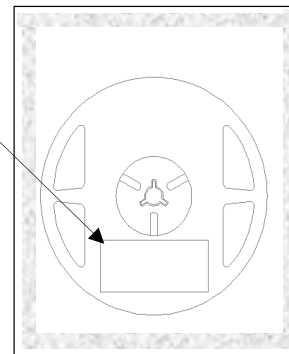

Inner Box

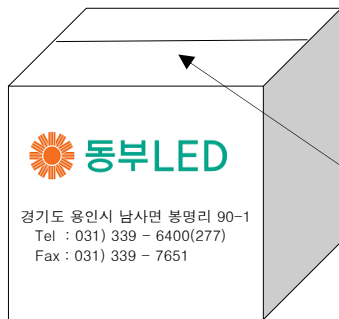

Box Label

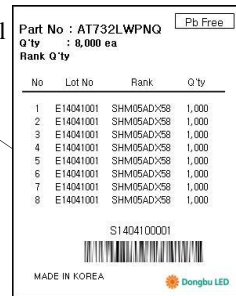

Outer Box

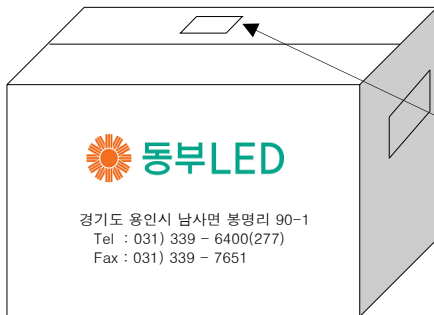

Box Type	Inner Box	Outer Box	
		Medium	Large
Max. Packing Q'ty(pcs)	8,000	32,000	64,000

(1) The carrier tape wound on the reel are placed into an ESD protected pack with a silicagel and sealed by the thermal pressure sealer. Then this sealed pack is packaged in a cardboard box.

## 7. Precaution

### (1) Static Electricity

These LEDs are highly susceptible to static electricity or surge voltage. So a wrist strap or an anti-electrostatic glove necessarily be used when handling the LEDs. Do not use the equipment that surge voltage is came into existence.

All devices and equipment that measure or mount the LEDs must be properly grounded.

After being assembled LEDs, it should be ascertained a electrical characteristic whether that are damaged by static electricity or not. It is easy to find the damaged LEDs by a light-on or VF test at forward a below 0.15mA current.

### (2) Packing

The moisture that is absorbed into the LED products may cause a badness and damage to the optical characteristics of the LEDs. Therefore the moisture barrier aluminum bag is used to keep moisture in the packing. And a silicagel is inserted into a moisture barrier aluminum bag that sealed by the thermal pressure sealer.

### (3) Cleaning

We greatly recommend IPA(solution) for LED cleaning and it should be limited exposure time for cleaning maximum 1 minute. (We can not guarantee the quality assurance if it has been used to other solution.)

It is recommended that isopropyl alcohol(IPA) be used as a solvent for cleaning the LEDs.

Do not clean the LEDs by the ultrasonic. When it use other solvents or is absolutely necessary ultrasonic, before cleaning, a pre-test should be done to confirm whether the LEDs are any damaged or not

### (4) Storage

In order to avoid the absorption of moisture, it is recommended to store LEDs in the moisture barrier aluminum bag is not opened.

Storage condition before opening the packing :

Temperature : below 30℃

Humidity : 90%RH max

The LEDs should be used within a year.

Storage condition after opening the packing :

Temperature : below 30℃

Humidity : 60%RH max

The products have to be used within one year from the date marked on label which is attached to reel or aluminium bag.

After opening the packing, the LEDs should be used within 168 hours(7days). If unused LEDs remain, they should be stored in the place kept away moisture.

If the LEDs have exceeded the above storage time, it should be used after to bake using the following conditions.

Baking condition : 60±5℃, more than 24 hours

**(5) Pick and Place**

It should be avoided to rub or scratch the surface of resin by any hard material. It is possible that the LEDs are damaged to the optical characteristics.

**(6) Heat**

The LEDs are products that are generated heat. Please consider the heat generation of the LED when it is designed the PCB. After considering the ambient temperature and the heat generation of LEDs, the operating current should be decided.

**(7) Others**

If the forward or reverse voltage which exceeds the absolute maximum rating is applied to the LEDs, that will cause the damage to the LEDs. It is possible that the damaged LEDs do not light on at the low current.

Be careful not to look the LEDs that the output power is strongly increased in the face. It is possible that eyesight has been getting weaker.

This specifications of the product may be revised without notice.

Light emitting part should not be exposed by physical contact. It can be the reason of material desquamation and progressive disconnection.

This LED is made for in-door use only. If the user wants the LED for out-door use, it is necessary to take some additional treatment on the product after surface mounting technology(SMT).

This specification could be changed without a notice to the customer because of the inside circumstance of the company.