

PRELIMINARY SPECIFICATIONS

SMD TYPE TOP VIEW WHITE COLOR LED

Model : AT374□W□EQ

Dongbu LED Co., Ltd.

90-1, Bongmyung-Ri, Namsa-Myun, Cheoin-Gu, Yongin-City, Gyeonggi-Do, Korea 449-882

Tel. : +82 - 70 - 7896 - 3600 Fax. : +82 - 31 - 339 - 7646

[http : //www.dongbuled-s.com](http://www.dongbuled-s.com)

1. General Description

(1) Features

- Package Size - 3.5(L) × 2.8(W) × 1.8(T) mm
- White Emission Package (Top View)

(2) Applications

- Backlighting(LCD, switches, keys, displays)
- Coupling into light guides
- Optical indicator
- Interior automotive lighting

(3) Outline Dimensions

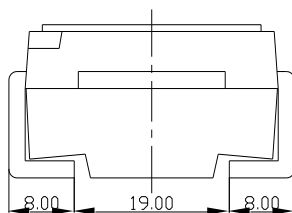
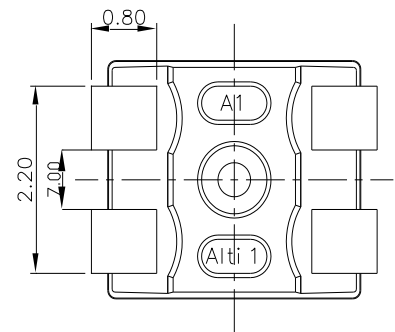
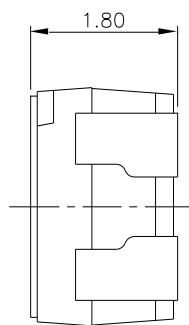
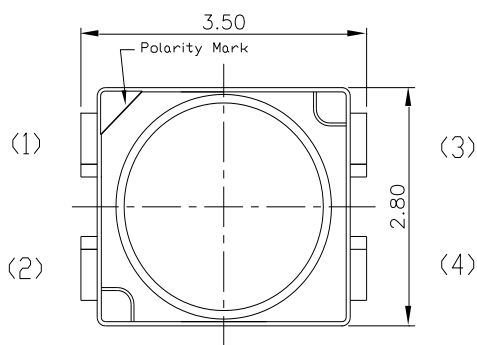

Internal Circuit Diagram

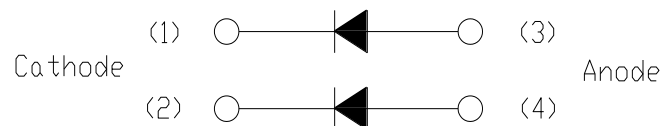

[Unit : mm]

2. Specifications

(1) Absolute maximum ratings

Parameter	Symbol	Absolute maximum rating	Unit	Remark
Power Dissipation	P_D	204	mW	
Forward Current	I_F	30	mA	Per die
Peak Pulse Current ⁽¹⁾	I_{FP}	80	mA	Per die
Reverse Voltage	V_R	5	V	
Operating Temperature	T_{OPR}	-30 to +85	°C	
Storage Temperature	T_{STG}	-40 to +100	°C	

Notes (1) Duty ratio = 1/10, pulse width = 10msec

(2) Initial Electrical/Optical Characteristics

($T_a=25^\circ\text{C}$)

Parameter	Symbol	Condition	Min.	Typ.	Max.	Unit
Forward Voltage ⁽¹⁾	V_F	$I_F = 40\text{mA}$	2.8	-	3.4	V
Luminous Intensity ⁽²⁾	I_V	$I_F = 40\text{mA}$	3.0	-	6.0	cd
Color Rendering Index	cri	$I_F = 40\text{mA}$	80	-	-	Ra
Reverse Current	I_R	$V_R = 5\text{V}$	-	-	10	μA

notes (1) Forward Voltage Measurement allowance is $\pm 10\%$.

(2) Luminous Intensity Measurement allowance is $\pm 10\%$, Measuring equipment : CAS140B(Instrument system)

(3) It should not measure the reverse current at $V_R=5\text{V}$, because there is a zener diode.

(3) Characteristics Rank

■ Forward voltage & Luminous intensity rank

($T_a=25^\circ\text{C}$)

Parameter	Symbol	Condition	Rank	Min.	Max.	Unit
Forward Voltage	V_F	$I_F = 40\text{mA}$	Z28	2.8	3.0	V
			Z30	3.0	3.2	
			Z32	3.2	3.4	
Luminous Intensity	I_V	$I_F = 40\text{mA}$	300	3.0	3.5	cd
			350	3.5	4.0	
			400	4.0	4.5	
			450	4.5	5.0	
			500	5.0	5.5	
			550	5.5	6.0	

(Based on the measuring instruments of Dongbu LED)

■ Color Rank

 (at $I_F=40mA$, $T_a=25^\circ C$)

	7A			
Cx	0.3028	0.3116	0.3140	0.3055
Cy	0.3374	0.3462	0.3330	0.3250

	7B			
Cx	0.3055	0.3140	0.3158	0.3077
Cy	0.3250	0.3330	0.3215	0.3145

	6A			
Cx	0.3116	0.3205	0.3215	0.3140
Cy	0.3462	0.3547	0.3410	0.3330

	6B			
Cx	0.3140	0.3215	0.3225	0.3158
Cy	0.3330	0.3410	0.3275	0.3215

	6C			
Cx	0.3205	0.3290	0.3292	0.3215
Cy	0.3547	0.3615	0.3480	0.3410

	6D			
Cx	0.3215	0.3292	0.3295	0.3225
Cy	0.3410	0.3480	0.3335	0.3275

	5A			
Cx	0.3290	0.3376	0.3370	0.3292
Cy	0.3615	0.3686	0.3550	0.3480

	5B			
Cx	0.3292	0.3370	0.3362	0.3295
Cy	0.3480	0.3550	0.3392	0.3335

	5C			
Cx	0.3376	0.3463	0.3450	0.3370
Cy	0.3686	0.3758	0.3610	0.3550

	5D			
Cx	0.3370	0.3450	0.3438	0.3362
Cy	0.3550	0.3610	0.3455	0.3392

	5E			
Cx	0.3463	0.3550	0.3530	0.3450
Cy	0.3758	0.3830	0.3660	0.3610

	5F			
Cx	0.3450	0.3530	0.3508	0.3438
Cy	0.3610	0.3660	0.3520	0.3455

	4A			
Cx	0.3551	0.3643	0.3620	0.3530
Cy	0.3830	0.3890	0.3730	0.3660

	4B			
Cx	0.3530	0.3620	0.3600	0.3508
Cy	0.3660	0.3730	0.3590	0.3520

	4C			
Cx	0.3643	0.3755	0.3720	0.3620
Cy	0.3890	0.3960	0.3800	0.3730

	4D			
Cx	0.3620	0.3720	0.3680	0.3600
Cy	0.3730	0.3800	0.3640	0.3590

	4E			
Cx	0.3755	0.3871	0.3828	0.3720
Cy	0.3960	0.4030	0.3870	0.3800

	4F			
Cx	0.3720	0.3828	0.3780	0.3680
Cy	0.3800	0.3870	0.3695	0.3640

	4G			
Cx	0.3871	0.4006	0.3950	0.3828
Cy	0.4030	0.4110	0.3950	0.3870

	4H			
Cx	0.3828	0.3950	0.3889	0.3780
Cy	0.3870	0.3950	0.3760	0.3695

	3A			
Cx	0.4006	0.4150	0.4095	0.3950
Cy	0.4110	0.4170	0.4005	0.3950

	3B			
Cx	0.3950	0.4095	0.4018	0.3889
Cy	0.3950	0.4005	0.3822	0.3760

	3C			
Cx	0.4150	0.4299	0.4223	0.4095
Cy	0.4170	0.4235	0.4059	0.4005

	3D			
Cx	0.4095	0.4223	0.4147	0.4018
Cy	0.4005	0.4059	0.3884	0.3822

	3E			
Cx	0.4299	0.4431	0.4345	0.4223
Cy	0.4235	0.4283	0.4105	0.4059

	3F			
Cx	0.4223	0.4345	0.4260	0.4147
Cy	0.4059	0.4105	0.3924	0.3884

	3G			
Cx	0.4431	0.4562	0.4467	0.4345
Cy	0.4283	0.4330	0.4147	0.4105

	3H			
Cx	0.4345	0.4467	0.4373	0.4260
Cy	0.4105	0.4147	0.3963	0.3924

	2A			
Cx	0.4562	0.4688	0.4590	0.4467
Cy	0.4330	0.4360	0.4180	0.4147

	2B			
Cx	0.4467	0.4590	0.4483	0.4373
Cy	0.4147	0.4180	0.3988	0.3963

	2C			
Cx	0.4688	0.4813	0.4709	0.4590
Cy	0.4360	0.4389	0.4210	0.4180

	2D			
Cx	0.4590	0.4709	0.4593	0.4483
Cy	0.4180	0.4210	0.4014	0.3988

Notes (1) Chromaticity coordinates measurement allowance is ± 0.01 .

(2) The Chromaticity coordinates refer to CIE 1931 chromaticity diagram.

(Based on the measuring instruments of Dongbu LED)

■ Chromaticity Diagram

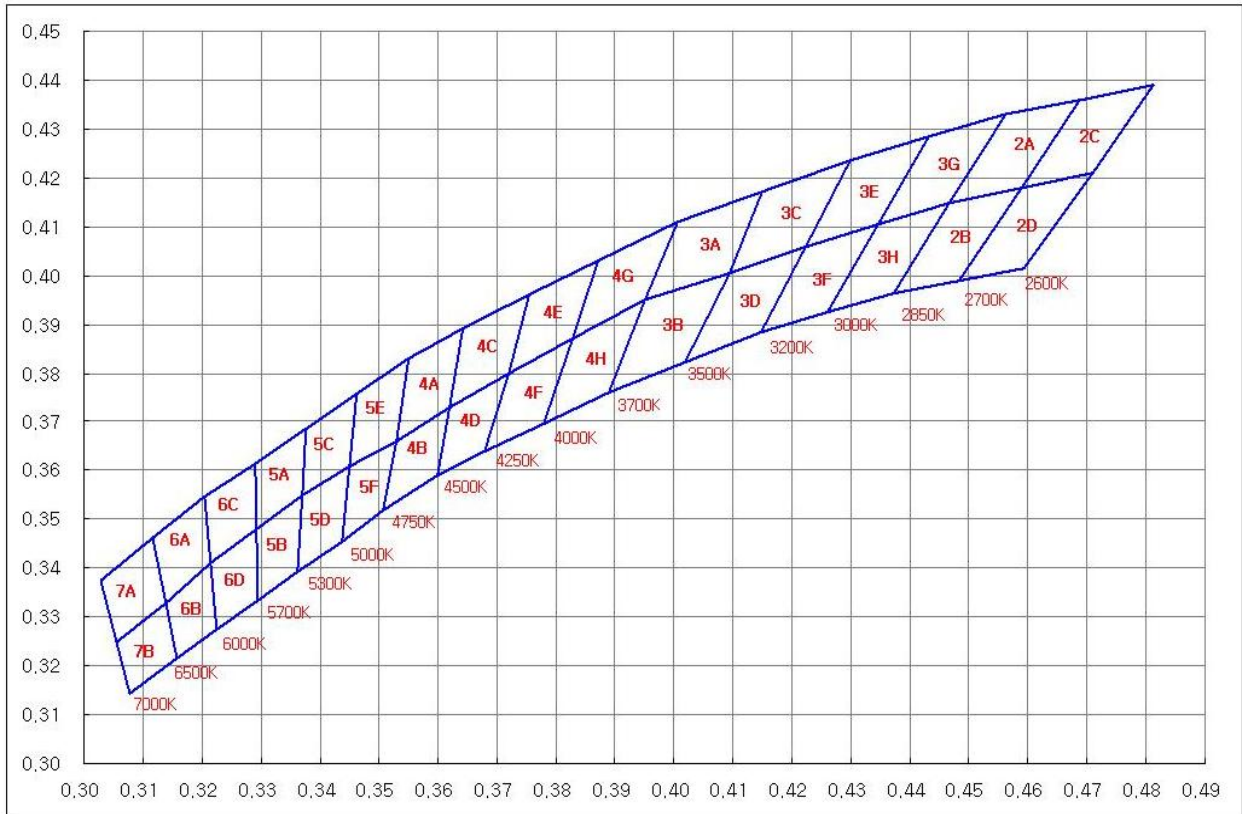

3. Rank

The rank inscription is composed of the follow method.

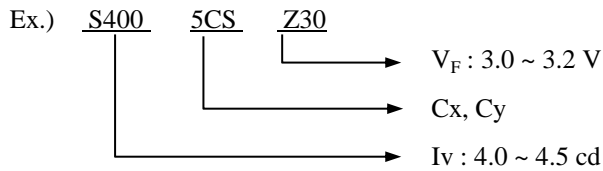

- S : Used 4 rank in one rank
- D : Used 2 vertical rank in one rank
- R : Used 2 horizontal rank in one rank

- ※ Ex) 5CS = 5C,5D,5E,5F
- 5CD = 5C,5D
- 5CR = 5C,5E

4. Characteristics Diagrams

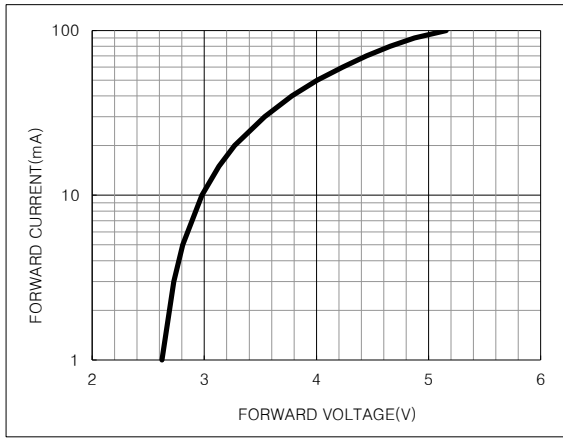

Forward Current vs Forward Voltage (Per die)

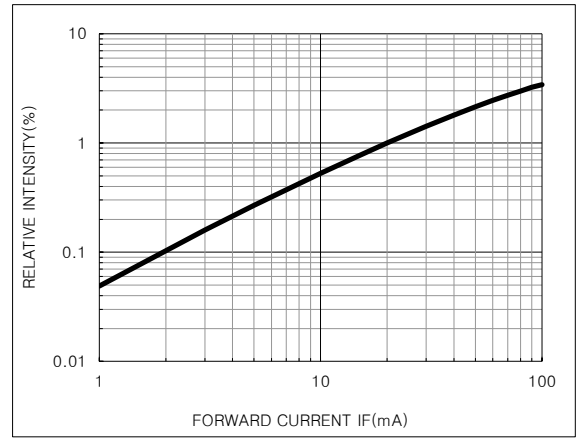

Relative Luminous Intensity vs Forward Current (Per die)

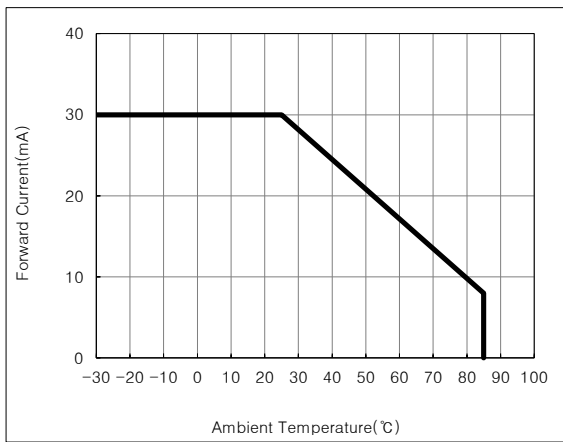

Forward Current vs. Ambient Temperature (Per die)

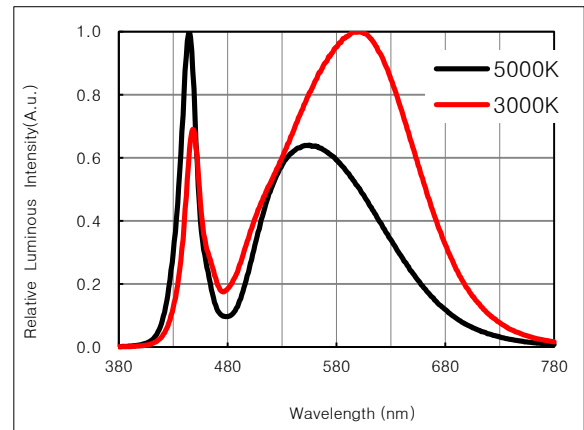

Relative Spectral Emission (Per die)

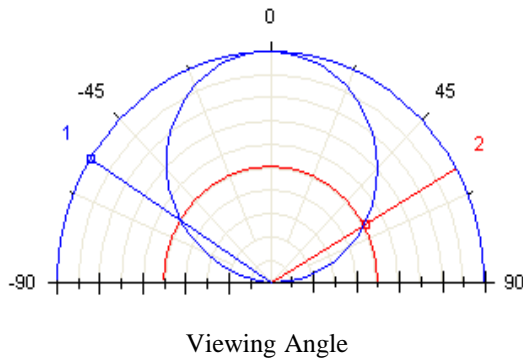

* The graph of characteristics is the sampling data for the reference.

5. Results of Reliability Tests
(1) Test Items and Results

Item	Test Condition	Notes	No. of Damaged
Temperature Cycle	-40℃ ~25℃ ~100℃ ~25℃ (30min~5min~30min~5min)	100Cycle	0/50
Steady State Operating Life	T _a = 25℃, I _F = 40mA	1000hrs.	0/50
Steady State Operating Life of High Temperature	T _a = 85℃, I _F = 40mA	1000hrs	0/50
Steady State Operating Life of High Humidity Heat	T _a = 60℃, RH = 90%, I _F = 40mA	1000hrs	0/50
Steady State Operating Life of Low Temperature	T _a = -30℃, I _F = 40mA	1000hrs	0/50
High Temperature Storage	T _a = 100℃	1000hrs.	0/50
High Temperature & Humidity Storage	T _a = 60℃, RH = 90%	1000hrs.	0/50
Low Temperature Storage	T _a = -40℃	1000hrs.	0/50
Resistance to Soldering Heat	T _{max} =260℃, 10sec (Pre treatment 30℃, 70%, 168hrs)	2 time	0/50

(2) Criteria for Judging the Damage

Parameter	Symbol	Condition	Criteria for Judgement	
			Min.	Max.
Forward Voltage	V _F	I _F = 40mA	-	U.S.L. ⁽¹⁾ * 1.2
Luminous Intensity	I _V	I _F = 40mA	L.S.L. ⁽²⁾ * 0.5	-
Reverse Current	I _R	V _R = 5V	-	10uA

Notes (1) U.S.L. : Upper Standard Level

(2) L.S.L. : Lower Standard Level

6. Soldering Conditions

(1) Recommended Soldering Conditions

Reflow Soldering			Hand Soldering	
	Lead Solder	Lead-Free Solder	Temperature Soldering time	350 °C Max. 3 sec. Max. (one time only)
Pre-Heating	120 ~ 150 °C	180 ~ 200 °C		
Pre-Heat Time	120sec. Max.	120sec. Max.		
Peak Temperature	240 °C Max.	260 °C Max.		
Soldering Time	5sec. Max.	5sec. Max.		

* After reflow soldering, Rapid cooling should be avoid.

(2) Recommended Reflow Soldering profile

■ Lead Solder

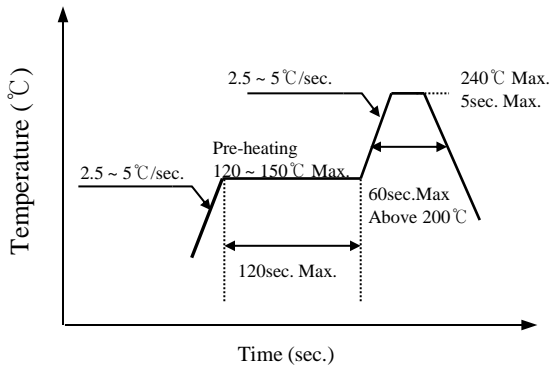

■ Lead-Free Solder

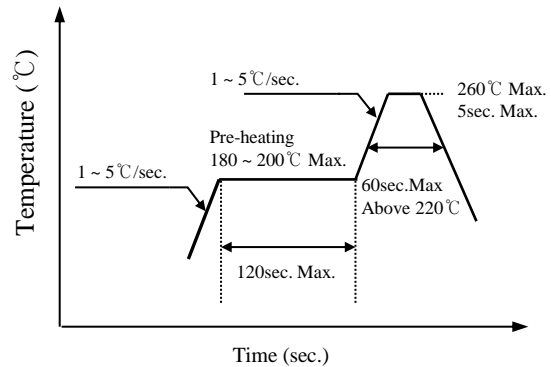

(3) Recommended Soldering Pattern

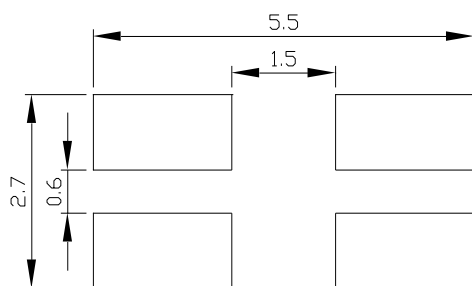

(4) Soldering Cautions

- Reflow soldering should not be done more than two times.
- When soldering, do not put stress on the LEDs during heating.
- After soldering, do not wrap the circuit board.
- The LEDs can be soldered on place using the reflow soldering method.
- Occasionally there is a brightness decrease cause by the influence of heat or ambient atmosphere during air reflow. It is recommend that the user use the nitrogen reflow method.

7. Packing

(1) Carrier Tape & Carrier Reel Dimensions

■ Carrier Tape

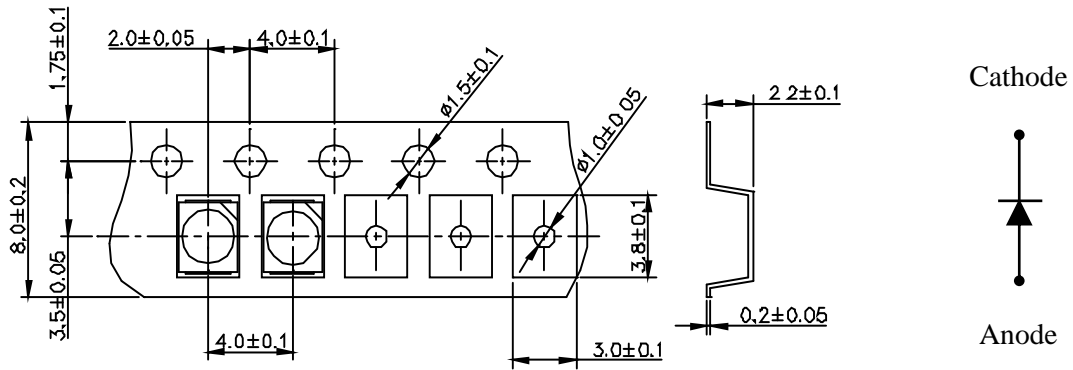

■ Carrier Reel

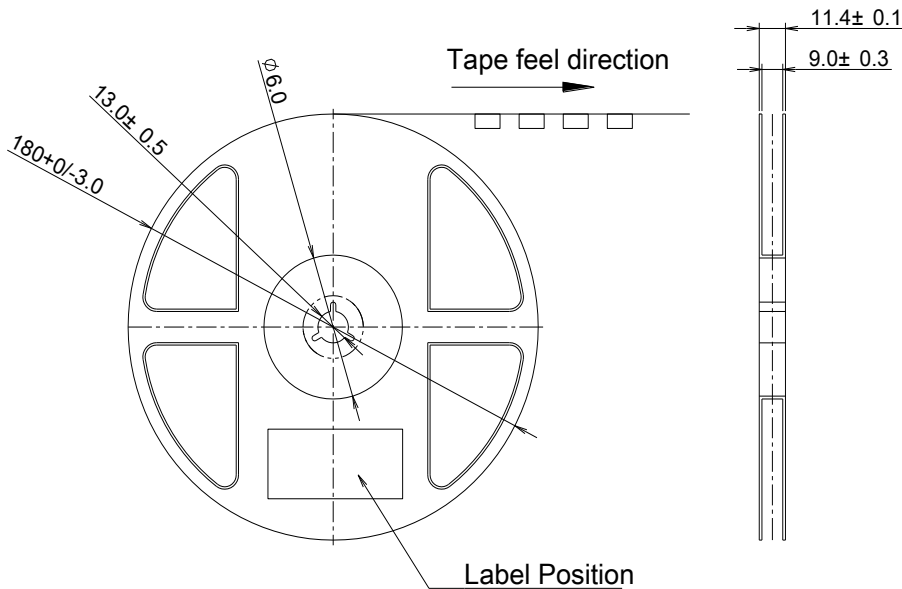

Notes (1) Quantity : 2,000pcs/reel

(2) Adhesion strength of cover tape is 0.1 ~ 0.7N when the cover tape is turned off from the carrier tape.

(2) Packing and Packaging

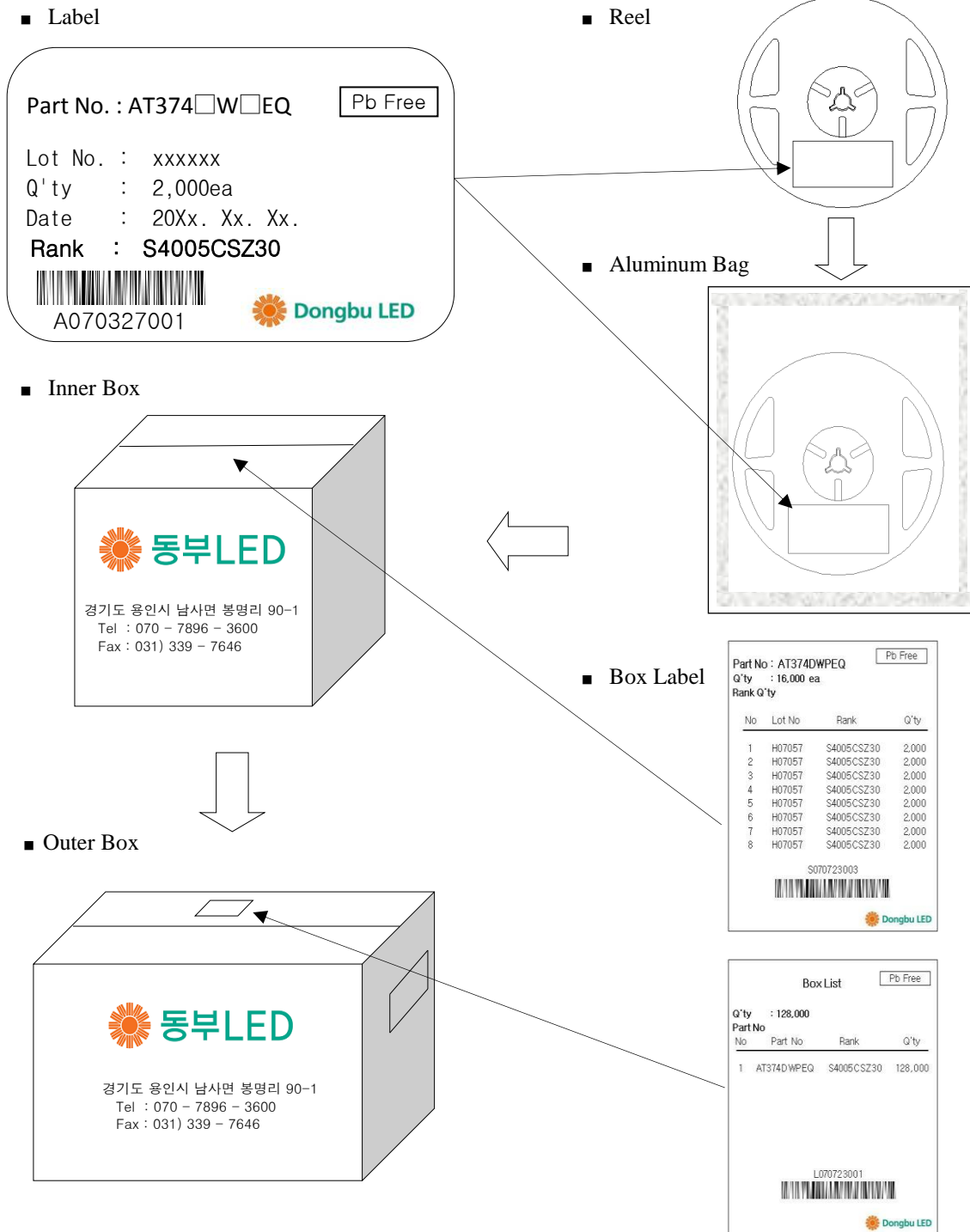

Box Type	Inner Box	Outer Box	
		Medium	Large
Max. Packing Q'ty(pcs)	16,000	64,000	128,000

(1) The carrier tape winded on the reel are placed into an ESD protected pack with a silicagel and sealed by the thermal pressure sealer. Then this sealed pack is packaged in a cardboard box.

8. Precaution

(1) Static Electricity

These LEDs are highly susceptible to static electricity or surge voltage. So a wrist strap or an anti-electrostatic glove necessarily be used when handling the LEDs. Do not use the equipment that surge voltage is came into existence.

All devices and equipment that measure or mount the LEDs must be properly grounded.

After being assembled LEDs, it should be ascertained a electrical characteristic whether that are damaged by static electricity or not. It is easy to find the damaged LEDs by a light-on or VF test at forward a below 0.15mA current.

(2) Packing

The moisture that is absorbed into the LED products may cause a badness and damage to the optical characteristics of the LEDs. Therefore the moisture barrier aluminum bag is used to keep moisture in the packing. And a silicagel is inserted into a moisture barrier aluminum bag that sealed by the thermal pressure sealer.

(3) Cleaning

We greatly recommend IPA(solution) for LED cleaning and it should be limited exposure time for cleaning maximum 1 minute. (We can not guarantee the quality assurance if it has been used to other solution.)

It is recommended that isopropyl alcohol(IPA) be used as a solvent for cleaning the LEDs.

Do not clean the LEDs by the ultrasonic. When it use other solvents or is absolutely necessary ultrasonic, before cleaning, a pre-test should be done to confirm whether the LEDs are any damaged or not

(4) Storage

In order to avoid the absorption of moisture, it is recommended to store LEDs in the moisture barrier aluminum bag is not opened.

Storage condition before opening the packing :

Temperature : below 30℃

Humidity : 90%RH max

The LEDs should be used within a year.

Storage condition after opening the packing :

Temperature : below 30℃

Humidity : 60%RH max

The products have to be used within one year from the date marked on label which is attached to reel or aluminium bag.

After opening the packing, the LEDs should be used within 168 hours(7days). If unused LEDs remain, they should be stored in the place kept away moisture.

If the LEDs have exceeded the above storage time, it should be used after to bake using the following conditions.

Baking condition : 60±5℃, more than 24 hours

(5) Pick and Place

It should be avoided to rub or scratch the surface of resin by any hard material. It is possible that the LEDs are damaged to the optical characteristics.

(6) Heat

The LEDs are products that are generated heat. Please consider the heat generation of the LED when it is designed the PCB. After considering the ambient temperature and the heat generation of LEDs, the operating current should be decided

(7) Others

If the forward or reverse voltage which exceeds the absolute maximum rating is applied to the LEDs, that will cause the damage to the LEDs. It is possible that the damaged LEDs do not light on at the low current.

Be careful not to look the LEDs that the output power is strongly increased in the face. It is possible that eyesight has been getting weaker.

This specifications of the product may be revised without notice.

Light emitting part should not be exposed by physical contact. It can be the reason of material desquamation and progressive disconnection.

This LED is made for in-door use only. If the user wants the LED for out-door use, it is necessary to take some additional treatment on the product after surface mounting technology(SMT).

This specification could be changed without a notice to the customer because of the inside circumstance of the company.