

PRELIMINARY SPECIFICATIONS

SMD TYPE TOP VIEW WHITE COLOR LED

Model : AP352MWSDE

Dongbu LED Co., Ltd.

90-1, Bongmyung-Ri, Namsa-Myun, Cheoin-Gu, Yongin-City, Gyeonggi-Do, Korea 449-882

Tel. : +82 - 31 - 339 - 6400 Fax. : +82 - 31 - 339 - 7651

[http : //www.dongbuled-s.com](http://www.dongbuled-s.com)

1. General Description

(1) Features

- Package Size - 3.5(L) × 3.5(W) × 2.25(T) mm
- SMT ceramic package with silicone resin with lens
- ESD-withstand voltage : up to 8KV acc. to JESD22-A114-D
- Wide view angle : 115°

(2) Applications

- General Lighting
- Street Light
- Flash, MR, PAR
- Bulb

(3) Outline Dimensions

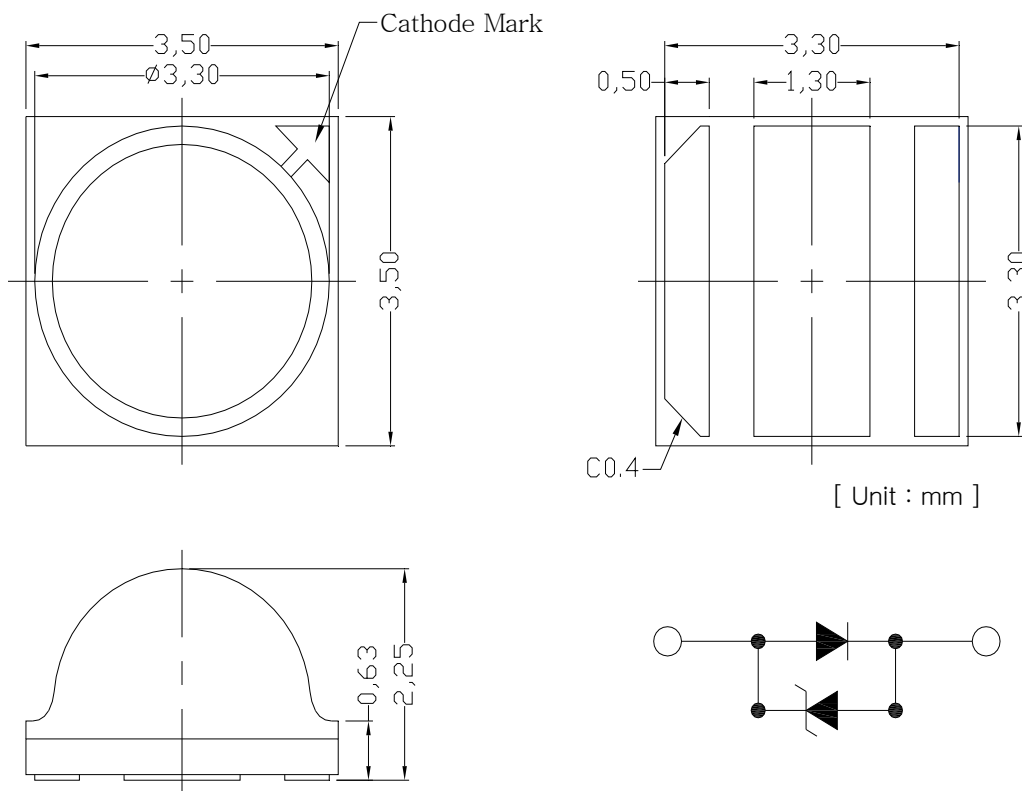

2. Specifications

(1) Absolute maximum ratings

Parameter	Symbol	Absolute maximum rating	Unit	Remark
Power Dissipation	P_D	3.5	W	
Forward Current	I_F	1,500	mA	
Peak Pulse Current ⁽¹⁾	I_{FP}	4,000	mA	
Reverse Voltage	V_R	1.2	V	
LED Junction Temperature	T_J	150	°C	
Operating Temperature	T_{OPR}	-40 to +85	°C	
Storage Temperature	T_{STG}	-40 to +100	°C	

Notes (1) Duty ratio = 1/10, pulse with = 10msec

(2) Initial Electrical/Optical Characteristics

($T_a=25^\circ\text{C}$)

Parameter	Symbol	Condition	Min.	Typ.	Max.	Unit
Forward Voltage ⁽¹⁾	V_F	$I_F = 350\text{mA}$	2.9	3.0	3.2	V
Luminous Flux ⁽²⁾	Φ_V	$I_F = 350\text{mA}$	-	125	-	lm
Reverse Voltage	V_R	$I_R = 5\text{mA}$	0.7	-	1.2	V
ESD		HBM		8,000		V
Thermal Resistance	$R_{th,j-s}$	$I_F = 350\text{mA}$	4.0			°C/W
View Angle		$I_F = 350\text{mA}$		115		degree

notes (1) Luminous Flux measuring equipment : CAS140CT(Instrument system)

(2) Luminous Flux Measurement allowance is $\pm 5\%$

(3) The coordinate refer to CIE 1931 chromaticity diagram.

(3) Characteristics Rank

■ Forward voltage & Luminous Flux rank

($T_a=25^\circ\text{C}$)

Parameter	Symbol	Condition	Rank	Min.	Typ.	Max.	Unit
Forward Voltage	V_F	$I_F = 350\text{mA}$	Z29	2.90	2.95	3.00	V
			Z30	3.00	3.05	3.10	
			Z31	3.10	3.15	3.20	
Lumimous Flux	Φ_V	CCT 5,500K $I_F =$ 350mA	L11	110.0	115.0	120.0	lm
			L12	120.0	125.0	130.0	
			L13	130.0	135.0	140.0	
		CCT 3,000K $I_F =$ 350mA	L09	85.0	90.0	95.0	lm
			L10	95.0	100.0	105.0	
			L11	105.0	110.0	115.0	

notes) Forward Voltage Measurement allowance is $\pm 0.05\text{V}$

■ Color Rank

	Cx	Cy		Cx	Cy
7A	0.3028	0.3374	7B	0.3055	0.3250
	0.3116	0.3462		0.3140	0.3330
	0.3140	0.3330		0.3158	0.3215
	0.3055	0.3250		0.3077	0.3145
	0.3028	0.3374		0.3055	0.3250
6A	0.3116	0.3462	6B	0.3140	0.3330
	0.3205	0.3547		0.3215	0.3410
	0.3215	0.3410		0.3225	0.3275
	0.3140	0.3330		0.3158	0.3215
	0.3116	0.3462		0.3140	0.3330
6C	0.3205	0.3547	6D	0.3215	0.3410
	0.3290	0.3615		0.3292	0.3480
	0.3292	0.3480		0.3295	0.3335
	0.3215	0.3410		0.3225	0.3275
	0.3205	0.3547		0.3215	0.3410
5A	0.3290	0.3615	5B	0.3292	0.3480
	0.3376	0.3686		0.3370	0.3550
	0.3370	0.3550		0.3362	0.3392
	0.3292	0.3480		0.3295	0.3335
	0.3290	0.3615		0.3292	0.3480
5C	0.3376	0.3686	5D	0.3370	0.3550
	0.3463	0.3758		0.3450	0.3610
	0.3450	0.3610		0.3438	0.3455
	0.3370	0.3550		0.3362	0.3392
	0.3376	0.3686		0.3370	0.3550
5E	0.3463	0.3758	5F	0.3450	0.3610
	0.3551	0.3830		0.3530	0.3660
	0.3530	0.3660		0.3508	0.3520
	0.3450	0.3610		0.3438	0.3455
	0.3463	0.3758		0.3450	0.3610
4A	0.3551	0.3830	4B	0.3530	0.3660
	0.3643	0.3890		0.3620	0.3730
	0.3620	0.3730		0.3600	0.3590
	0.3530	0.3660		0.3508	0.3520
	0.3551	0.3830		0.3530	0.3660
4C	0.3643	0.3890	4D	0.3620	0.3730
	0.3755	0.3960		0.3720	0.3800
	0.3720	0.3800		0.3680	0.3640
	0.3620	0.3730		0.3600	0.3590
	0.3643	0.3890		0.3620	0.3730

	Cx	Cy		Cx	Cy
4E	0.3755	0.3960	4F	0.3720	0.3800
	0.3871	0.4030		0.3828	0.3870
	0.3828	0.3870		0.3780	0.3695
	0.3720	0.3800		0.3680	0.3640
	0.3755	0.3960		0.3720	0.3800
4G	0.3871	0.4030	4H	0.3828	0.3870
	0.4006	0.4110		0.3950	0.3950
	0.3950	0.3950		0.3889	0.3760
	0.3828	0.3870		0.3780	0.3695
	0.3871	0.4030		0.3828	0.3870
3A	0.4006	0.4110	3B	0.3950	0.3950
	0.4150	0.4170		0.4095	0.4005
	0.4095	0.4005		0.4018	0.3822
	0.3950	0.3950		0.3889	0.3760
	0.4006	0.4110		0.3950	0.3950
3C	0.4150	0.4170	3D	0.4095	0.4005
	0.4299	0.4235		0.4223	0.4059
	0.4223	0.4059		0.4147	0.3884
	0.4095	0.4005		0.4018	0.3822
	0.4150	0.4170		0.4095	0.4005
3E	0.4299	0.4235	3F	0.4223	0.4059
	0.4431	0.4283		0.4345	0.4105
	0.4345	0.4105		0.4260	0.3924
	0.4223	0.4059		0.4147	0.3884
	0.4299	0.4235		0.4223	0.4059
3G	0.4431	0.4283	3H	0.4345	0.4105
	0.4562	0.4330		0.4467	0.4147
	0.4467	0.4147		0.4373	0.3963
	0.4345	0.4105		0.4260	0.3924
	0.4431	0.4283		0.4345	0.4105
2A	0.4562	0.4330	2B	0.4467	0.4147
	0.4688	0.4360		0.4590	0.4180
	0.4590	0.4180		0.4483	0.3988
	0.4467	0.4147		0.4373	0.3963
	0.4562	0.4330		0.4467	0.4147
2C	0.4688	0.4360	2D	0.4590	0.4180
	0.4813	0.4389		0.4709	0.4210
	0.4709	0.4210		0.4593	0.4014
	0.4590	0.4180		0.4483	0.3988
	0.4688	0.4360		0.4590	0.4180

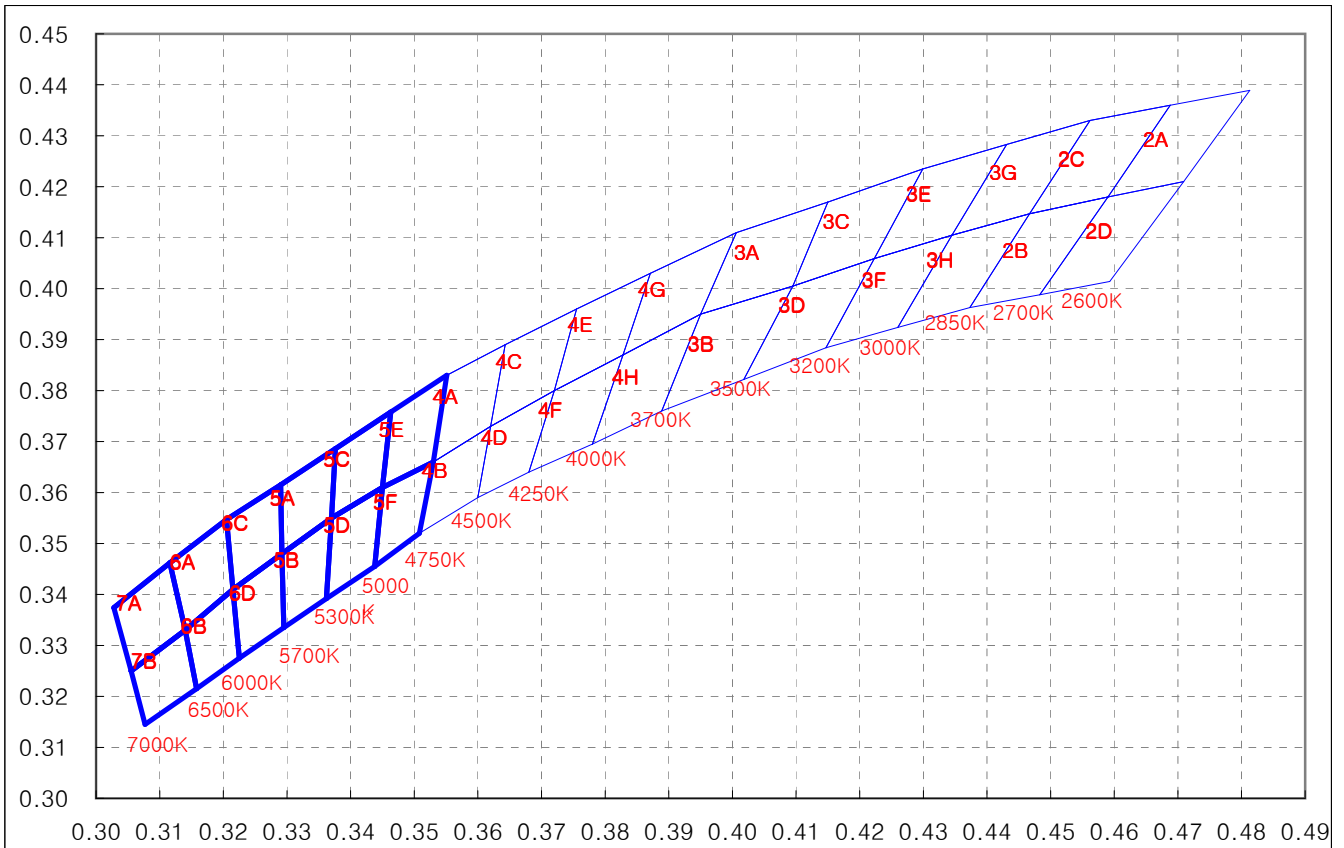

- Notes :
- (1) Chromaticity Measurement allowance is ± 0.005 (CCx , CCy)
 - (2) Color Rendering Index Measurement allowance is ± 2
 - (3) Typical CRI for Cool White (5,000K - 7,000K) is 75
 - (4) Minimum CRI for Warm White (2,700K - 3,200K) is 80

3.Rank

The Rank inscription is composed of the follow method.

Ex) Z30 5A L11

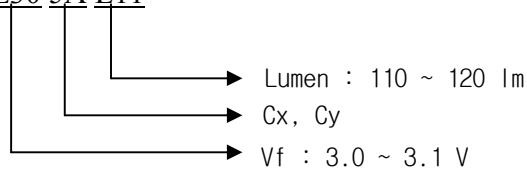

4. Characteristics Diagrams

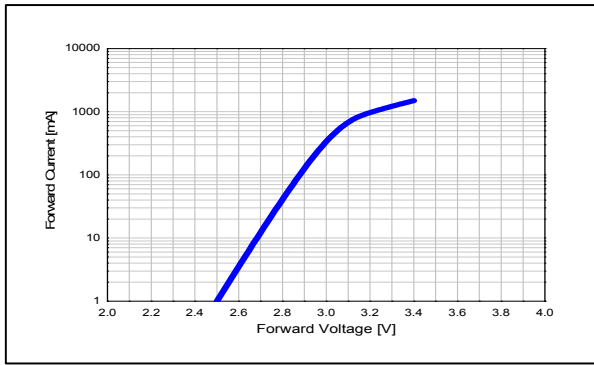

Forward Current vs Forward Voltage

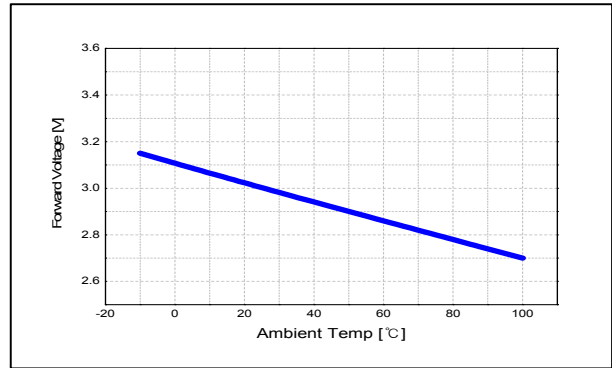

Ambient Temperature vs Forward Voltage

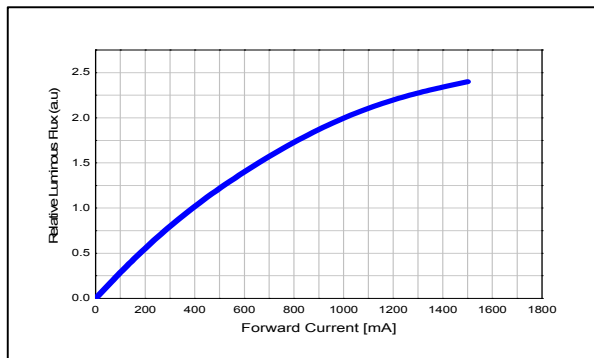

Relative Luminous Flux vs Forward Current

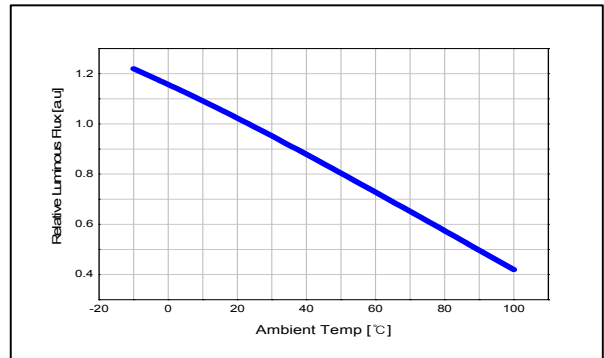

Relative Luminous Flux vs Ambient Temperature

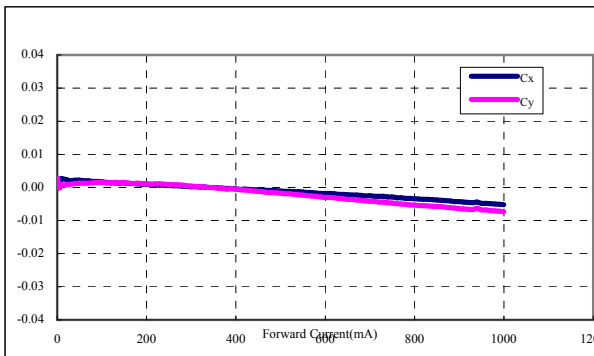

Relative Chromaticity vs Forward Current (Warm White)

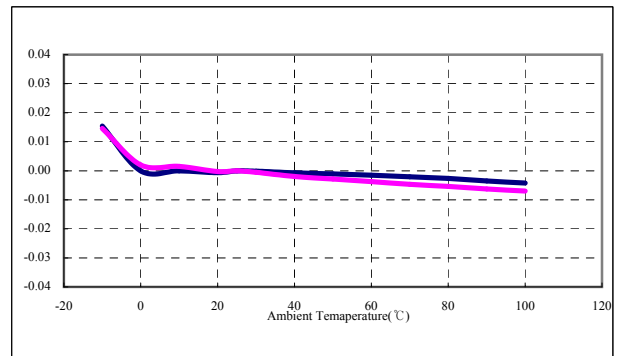

Relative Chromaticity vs Ambient Temperature (Warm White)

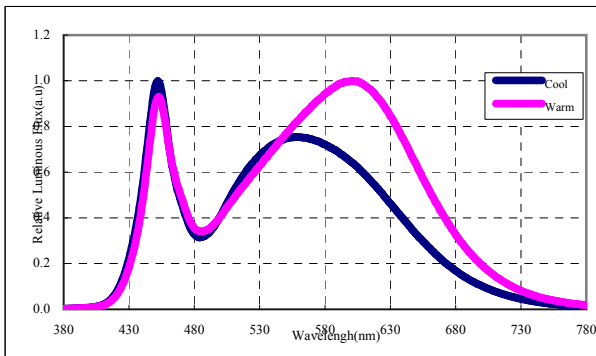

Relative Spectral Emission

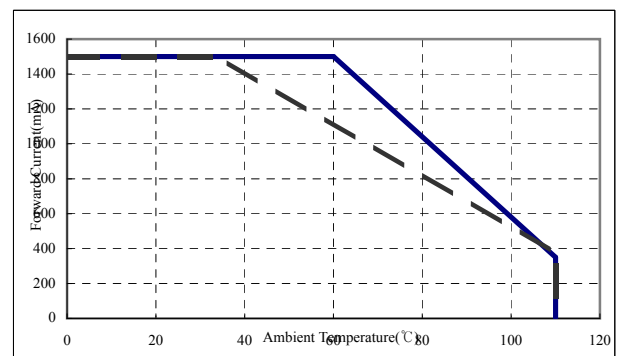

Maximum Forward Current vs Ambient Temperature

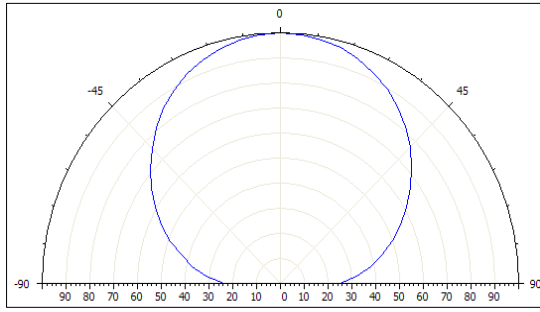

View Angle (X-X)

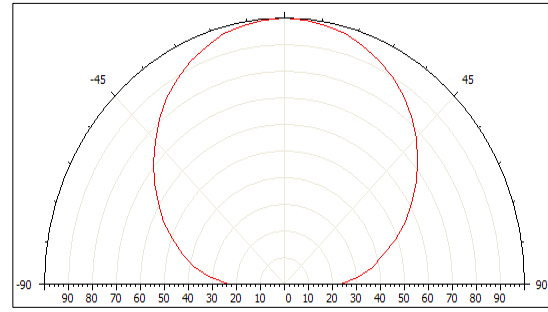

View Angle (Y-Y)

5. Results of Reliability Tests

(1) Test Items and Results

Item	Test Condition	Hours/Cycle	No. of Damaged
Steady State Operating Life	Ta = 25 °C (Ts=55 °C), IF = 700mA	1000hrs.	0/20
High Temp. Humidity Life	Ta = 85 °C, RH = 85%, IF = 700mA	1000hrs.	0/20
Steady State Operating Life of High Temperature 1	Ta = 60 °C (Ts=85 °C), IF = 700mA	1000hrs.	0/20
Steady State Operating Life of High Temperature 2	Ta = 85 °C (Ts=95 °C), IF = 700mA	1000hrs.	0/20
Low Temp. Humidity Life	Ta = -40 °C, IF = 700mA	1000hrs.	0/20
High Temperature Storage	Ta = 100 °C	1000hrs.	0/20
High Temperature & Humidity Storage	Ta = 85 °C, RH = 85%	1000hrs.	0/20
Low Temperature Storage	Ta = -40 °C	1000hrs.	0/20
Temperature Cycle	-40 °C ~ 25 °C ~ 100 °C ~ 25 °C (30min ~ 5min ~ 30min ~ 5min)	100Cycle	0/20
Thermal Shock	100 °C ~ 25 °C ~ -40 °C (15min ~ 5min ~ 15min)	100Cycle	0/20
Solderability(Reflow Soldering)	Tsld=215±5 °C, 5sec Lead-Free Solder(Using Flux)	1 times	0/20
Resistance to Soldering Heat	Tmax=260 °C, 10sec (Pre treatment 30 °C, 70%, 168hrs)	2 times	0/20
Electrostatic Discharge(HBM, ± 8KV)	R=1.5KΩ, C=100pF, Test Voltage 5KV (Negaive / Positive)	3 times	0/20

(2) Criteria for Judging the Damage

Parameter	Symbol	Condition	Criteria for Judgement	
			Min.	Max.
Forward Voltage	V_F	$I_F = 700\text{mA}$	-	U.S.L. ⁽¹⁾ * 1.2
Luminous Intensity	I_v	$I_F = 700\text{mA}$	L.S.L. ⁽²⁾ * 0.7	-
Reverse Current	I_R	$V_R = 1.2\text{V}$	-	-

Notes (1) U.S.L. : Upper Specification Level

(2) L.S.L. : Lower Specification Level

6. Soldering Conditions

(1) Recommended Soldering Conditions

Reflow Soldering			Hand Soldering	
	Lead Solder	Lead-Free Solder	Temperature Soldering time	300°C Max. 3 sec. Max. (one time only)
Pre-Heating	120 ~ 150°C	180 ~ 200°C		
Pre-Heat Time	120sec. Max.	120sec. Max.		
Peak Temperature	240°C Max.	260°C Max.		
Soldering Time	10sec. Max.	10sec. Max.		

* After reflow soldering, Rapid cooling should be avoid.

(2) Recommended Reflow Soldering profile

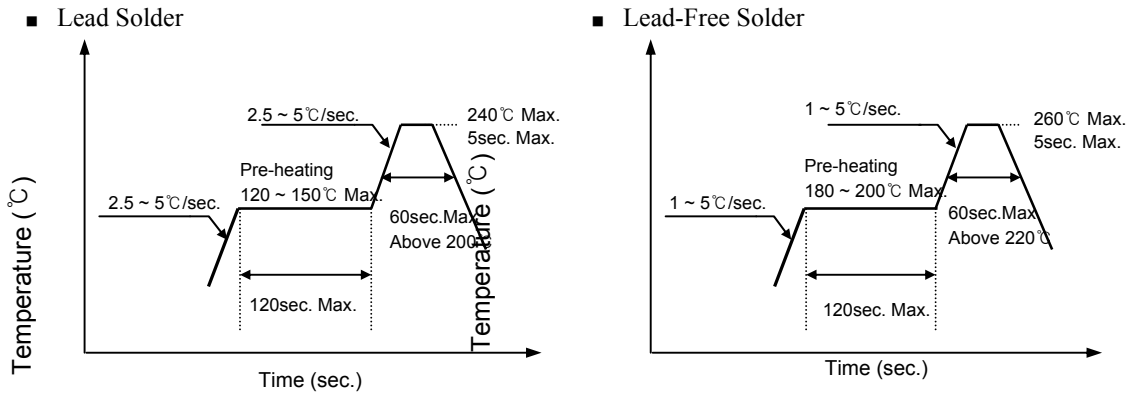

(3) Recommended Soldering Pattern

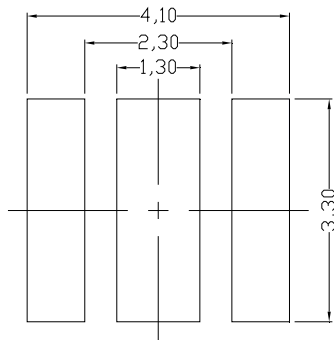

(Unit : mm)

(2) Packing and Packaging

■ Label

Part No. : AP352xxxDE Pb Free

Lot No. : xxxxxx

Q'ty : 1,000ea

Date : 20xx. Xx. Xx.



A070327001 

■ Reel

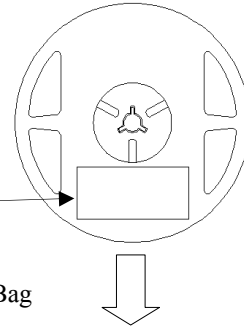

■ Aluminum Bag

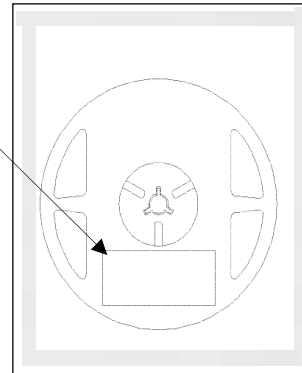

■ Inner Box

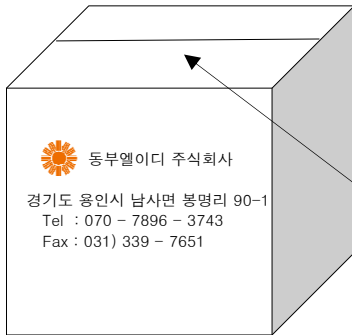

■ Box Label

Part No : AP352LWSDE
Q'ty : 24,000 ea
Rank Q'ty

No	Lot No	Rank	Q'ty
1	H07057	Z305AZ30	1,000
2	H07057	Z305AZ30	1,000
3	H07057	Z305AZ30	1,000
4	H07057	Z305AZ30	1,000
5	H07057	Z305AZ30	1,000
6	H07057	Z305AZ30	1,000
7	H07057	Z305AZ30	1,000
8	H07057	Z305AZ30	1,000

■ Outer Box



S070723003



Box Type	Inner Box	Outer Box	
		Medium	Large
Max. Packing Q'ty(pcs)	4,000	16,000	

(1) The carrier tape wound on the reel are placed into an ESD protected pack and sealed by the thermal pressure sealer. Then this sealed pack is pack

L070723001



8. Precaution

(1) Static Electricity

These LEDs are highly susceptible to static electricity or surge voltage. So a wrist strap or an anti-electrostatic glove necessarily be used when handling the LEDs. Do not use the equipment that surge voltage is came into existence.

All devices and equipment that measure or mount the LEDs must be properly grounded.

After being assembled LEDs, it should be ascertained a electrical characteristic whether that are damaged by static electricity or not. It is easy to find the damaged LEDs by a light-on or VF test at forward a below 1mA current.

(2) Packing

The moisture that is absorbed into the LED products may cause a badness and damage to the optical characteristics of the LEDs. Therefore the moisture barrier aluminum bag is used to keep moisture in the packing. And a silicagel is inserted into a moisture barrier aluminum bag that sealed by the thermal pressure sealer.

(3) Cleaning

It is recommended that isopropyl alcohol(IPA) be used as a solvent for cleaning the LEDs.

Do not clean the LEDs by the ultrasonic. When it use other solvents or is absolutely necessary ultrasonic, before cleaning, a pre-test should be done to confirm whether the LEDs are any damaged or not

(4) Storage

In order to avoid the absorption of moisture, it is recommended to store LEDs in the moisture barrier aluminum bag is not opened.

Storage condition before opening the packing :

Temperature : below 30°C

Humidity : 90%RH max

The LEDs should be used within a year.

Storage condition after opening the packing :

Temperature : below 30°C

Humidity : 60%RH max

After opening the packing, the LEDs should be used within 168 hours(7days). If unused LEDs remain, they should be stored in the place kept away moisture.

If the LEDs have exceeded the above storage time, it should be used after to bake using the following conditions.

Baking condition : 60±5°C, more than 24 hours

(5) Pick and Place

It should be avoided to rub or scratch the surface of resin by any hard material. It is possible that the LEDs are damaged to the optical characteristics.

(6) Heat

The LEDs are products that are generated heat. Please consider the heat generation of the LED when it is designed the PCB. After considering the ambient temperature and the heat generation of LEDs, the operating current should be decided

(7) Others

If the forward or reverse voltage which exceeds the absolute maximum rating is applied to the LEDs, that will cause the damage to the LEDs. It is possible that the damaged LEDs do not light on at the low current.

Be careful not to look the LEDs that the output power is strongly increased in the face. It is possible that eyesight has been getting weaker.

This specifications of the product may be revised without notice.