

S P E C I F I C A T I O N S

- Preliminary -

CHIP ON BOARD WHITE POWER LED

Model : C500PEW

Product	R&D	QC	Sale

Dongbu LED Co., Ltd.

90-1, Bongmyung-Ri, Namsa-Myun, Cheoin-Gu, Yongin-City, Gyeonggi-Do, Korea 449-882

Tel. : +82 - 70 - 7896 - 3600 Fax. : +82 - 31 - 339 - 7646

[http : //www.dongbuled-s.com](http://www.dongbuled-s.com)

※ Suggested values in this preliminary specification can be changed without notice.

Contents

Index	Page
1. General Features	3
2. Outline Dimensions	3
3. Specifications	4
4. Binnings	8
5. Characteristics Diagrams	10
6. Results of Reliability Test	15
8. Precaution for Use	16

1. General Features

- ▶ Aluminum Base Chip on Board Package
- ▶ Dimensions : 74 x 74 x 1.45 (mm)

2. Outline Dimensions

General Tolerance : ± 0.1
[Unit : mm]

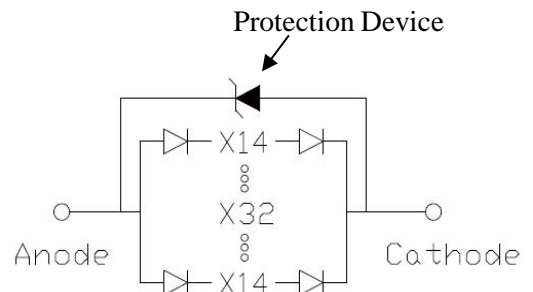
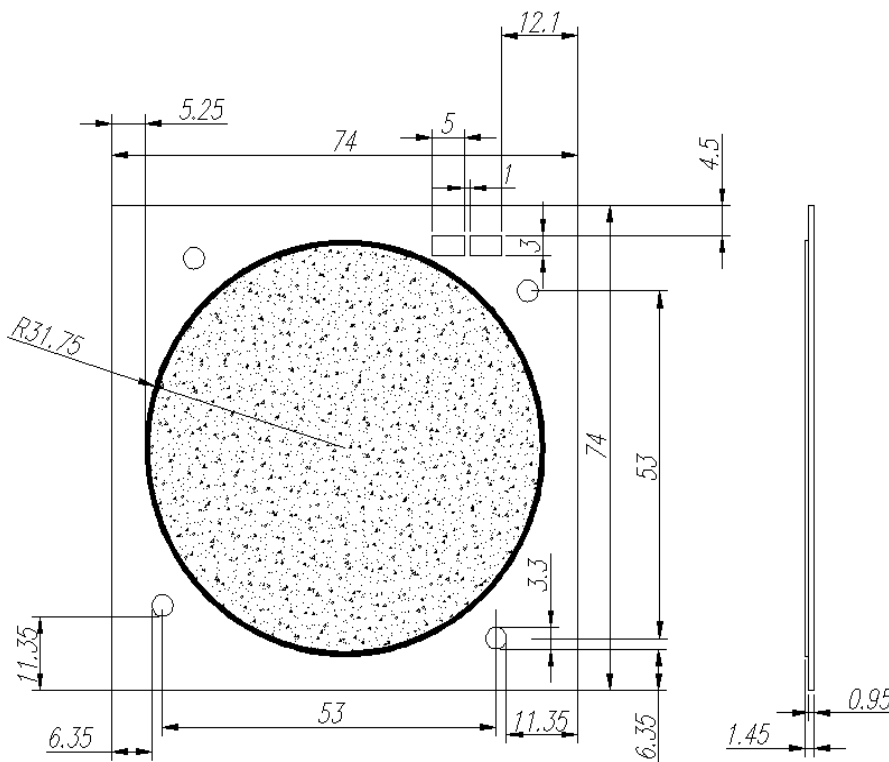

3. Specifications

(1) Absolute Maximum Ratings

Parameter	Symbol	Absolute Maximum Rating	Unit
Power Dissipation	P_D	246.4	W
Forward Current	I_F	5600	mA
Operating Temperature	T_{OPR}	-30 to +85	°C
Storage Temperature	T_{STG}	-40 to +100	°C
Junction Temperature	T_j	125	°C

*Forward Currents are the values when the LED is used within the range of the derating curve in this data sheet.

(2) Initial Electrical/Optical Characteristics

($T_a=25^\circ\text{C}$)

Parameter	Symbol	Condition	Min.	Typ.	Max.	Unit
Forward Voltage ⁽¹⁾	V_F	$I_F=3840\text{mA}$	40.0	-	44.0	V
Luminous Flux (Cool White) ⁽²⁾	Φ_V		19661	21846	-	lm
Luminous Flux (Warm White) ⁽²⁾	Φ_V		17933	19926	-	lm
Color Rendering Index ⁽³⁾	CRI		80	-	-	Ra

Notes (1) Forward Voltage Measurement allowance is $\pm 10\%$.

(2) Luminous Flux Measurement allowance is $\pm 10\%$

(3) Color Rendering Index Measurement allowance is ± 3 .

(4) Initial Electrical/Optical Characteristics can be changed without notice.

(4) Chromaticity Coordinates

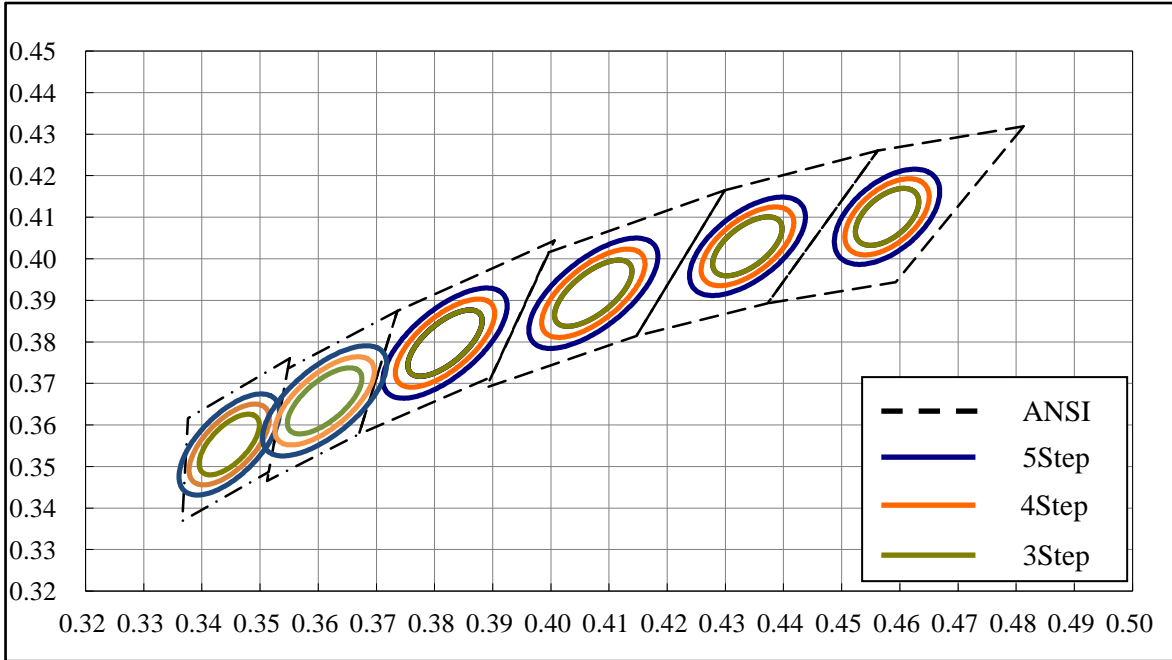

	5000K		4500K		4000K	
	Cx	Cy	Cx	Cy	Cx	Cy
Center	0.3447	0.3553	0.3661	0.3658	0.3818	0.3797
ANSI	0.3551	0.376	0.3736	0.3874	0.4006	0.4044
	0.3376	0.3616	0.3548	0.3736	0.3736	0.3874
	0.3366	0.3369	0.3512	0.3465	0.367	0.3578
	0.3515	0.3487	0.3670	0.3578	0.3898	0.3716
	3500K		3000K		2700K	
	Cx	Cy	Cx	Cy	Cx	Cy
Center	0.4073	0.3717	0.4338	0.403	0.4578	0.4101
ANSI	0.4299	0.4165	0.4562	0.426	0.4813	0.4319
	0.3996	0.4015	0.4299	0.4165	0.4562	0.426
	0.3889	0.369	0.4147	0.3814	0.4373	0.3893
	0.4147	0.3814	0.4373	0.3893	0.4593	0.3944

* MacAdam Ellipse Center refers to ANSI C78.377:2008.

2700K - 5Step		Xc	Yc	3000K - 5Step		Xc	Yc
T27	CIE	0.4578	0.4101	T30	CIE	0.4338	0.4030
	a	0.0129			a	0.0139	
	b	0.00685			b	0.0068	
	Θ	57.17°			Θ	53.1°	
3500K - 5Step		Xc	Yc	4000K - 5Step		Xc	Yc
T35	CIE	0.4073	0.3917	T40	CIE	0.3818	0.3797
	a	0.01585			a	0.01565	
	b	0.00695			b	0.0067	
	Θ	52.58°			Θ	54°	
4500K - 5Step		Xc	Yc	5000K - 5Step		Xc	Yc
T45	CIE	0.3611	0.3658	T50	CIE	0.3818	0.3797
	a	0.01565			a	0.01565	
	b	0.0067			b	0.0067	
	Θ	54°			Θ	54°	

2700K - 4Step		Xc	Yc	3000K - 4Step		Xc	Yc
U27	CIE	0.4578	0.4101	U30	CIE	0.4338	0.4030
	a	0.0103			a	0.0111	
	b	0.00548			b	0.00544	
	Θ	57.17°			Θ	53.1°	
3500K - 4Step		Xc	Yc	4000K - 4Step		Xc	Yc
U35	CIE	0.4073	0.3917	U40	CIE	0.3818	0.3797
	a	0.01268			a	0.01252	
	b	0.00556			b	0.00536	
	Θ	52.58°			Θ	54°	
4500K - 4Step		Xc	Yc	5000K - 4Step		Xc	Yc
U45	CIE	0.3611	0.3658	U50	CIE	0.3818	0.3797
	a	0.01252			a	0.01096	
	b	0.00536			b	0.00472	
	Θ	54°			Θ	59.37°	

2700K - 3Step		Xc	Yc	3000K - 3Step		Xc	Yc
V27	CIE	0.4578	0.4101	V30	CIE	0.4338	0.4030
	a	0.0077			a	0.0083	
	b	0.00411			b	0.00408	
	Θ	57.17°			Θ	53.1°	
3500K - 3Step		Xc	Yc	4000K - 3Step		Xc	Yc
V35	CIE	0.4073	0.3917	V40	CIE	0.3818	0.3797
	a	0.00951			a	0.00939	
	b	0.00417			b	0.00402	
	Θ	52.58°			Θ	54°	
4500K - 3Step		Xc	Yc	5000K - 3Step		Xc	Yc
V45	CIE	0.3611	0.3658	V50	CIE	0.3818	0.3797
	a	0.00939			a	0.00822	
	b	0.00402			b	0.00354	
	Θ	54°			Θ	59.37°	

* Xc : Ellipse center of X-Coordinate, Yc : Ellipse center of Y-Coordinate

* a : Length of the major axis of Ellipse, b : Length of the minor axis of Ellipse

* Θ : Angle of Ellipse

4. Binnings

(1) Luminous Flux

Parameter	Condition	Rank	Min.	Max.	Unit
Luminous Flux	IF =3840mA	740	7400	7900	lm
		790	7900	8400	
		890	8900	9400	
		990	9900	10400	
		1090	10900	11400	
		1190	11900	12400	
		1290	12900	13400	
		1390	13900	14400	
		1490	14900	15400	
		1590	15900	16400	
		1690	16900	17400	
		1790	17900	18400	
		1890	18900	19400	
		1990	19900	20400	
		2090	20900	21400	
		2190	21900	22400	
		2290	22900	23400	
2390	23900	24400			
2490	24900	25400			
2590	25900	26400			

(2) Forward Voltage

Parameter	Condition	Rank	Min.	Max.	Unit
Forward Voltage	IF =3840mA	404	40.0	44.0	V

(3) Chromaticity Coordinates

-. MacAdam 5 Step

Parameter	Condition	Rank	CCT	Unit
Chromaticity Coordinate	IF = 3840mA	T27	2700	K
		T30	3000	
		T35	3500	
		T40	4000	
		T45	4500	
		T50	5000	

-. MacAdam 4 Step

Parameter	Condition	Rank	CCT	Unit
Chromaticity Coordinate	IF = 3840mA	U27	2700	K
		U30	3000	
		U35	3500	
		U40	4000	
		U45	4500	
		U50	5000	

-. MacAdam 3 Step

Parameter	Condition	Rank	CCT	Unit
Chromaticity Coordinate	IF = 3840mA	V27	2700	K
		V30	3000	
		V35	3500	
		V40	4000	
		V45	4500	
		V50	5000	

(4) Color Rendering Index

Parameter	Condition	Rank	Min.	R9	Unit
CRI	IF = 3840mA	080	80.0	-	-

5. Characteristics Diagrams

(1) Relative Spectral Power Distribution(Spectrum)

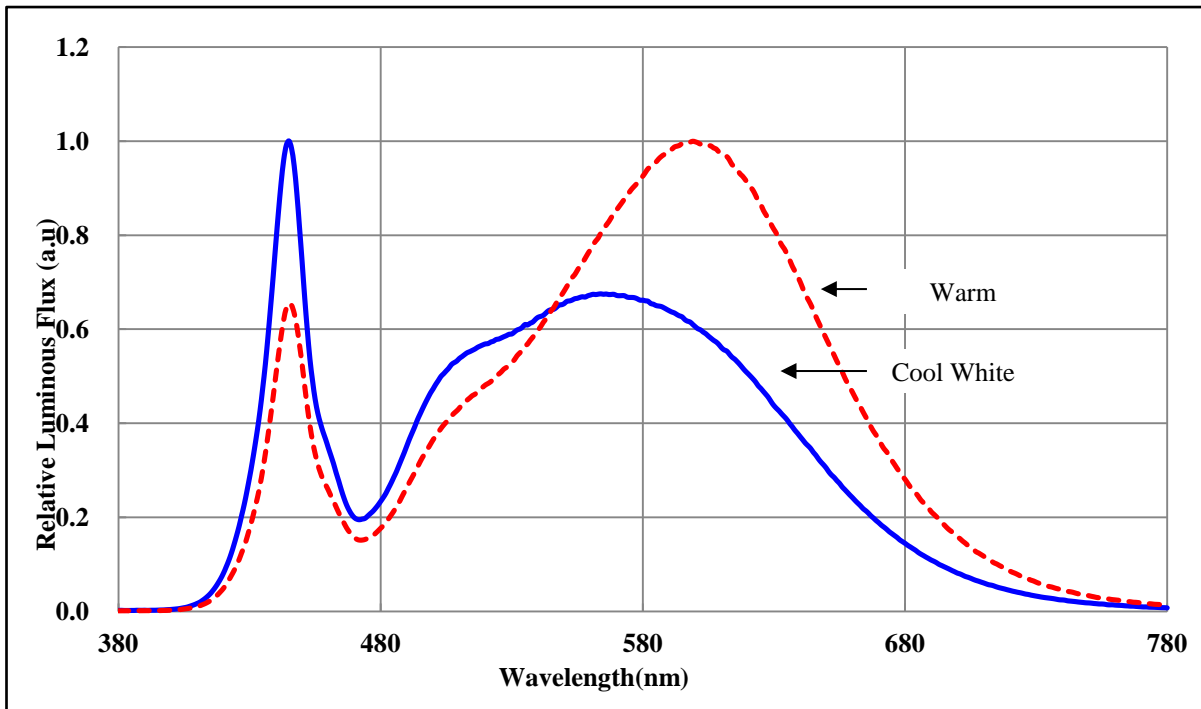

(2) Radiation Pattern

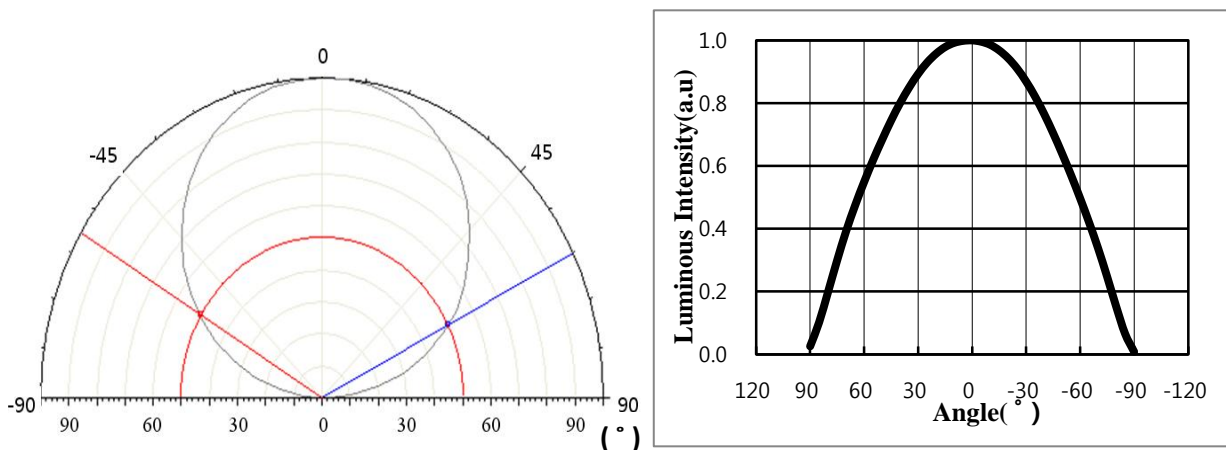

(3) Forward Voltage vs. Forward Current

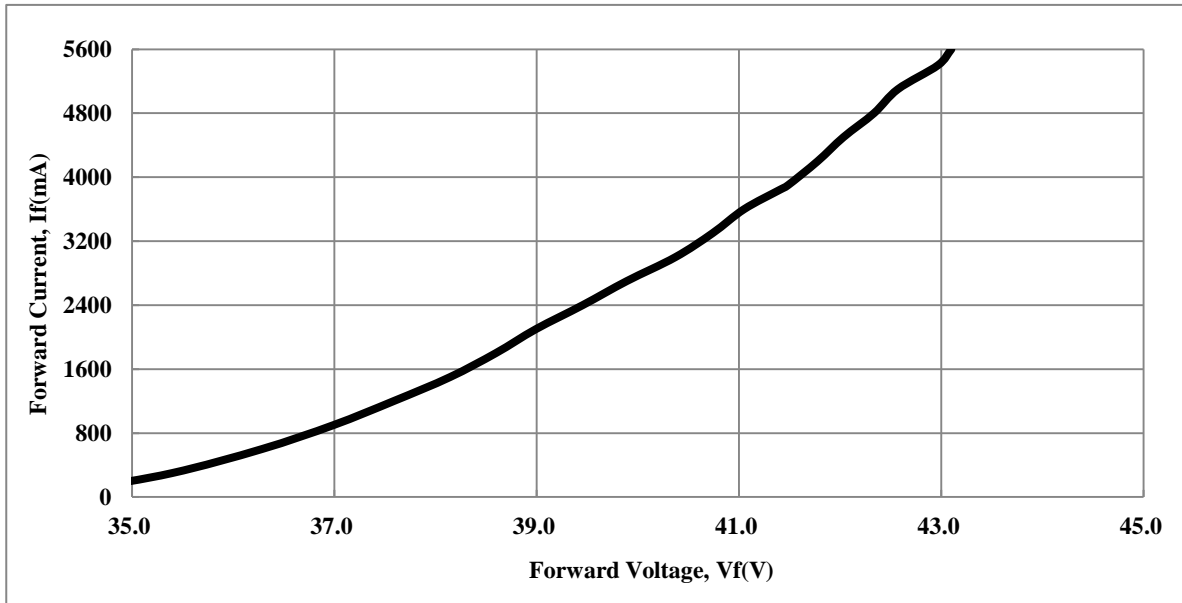

(4) Forward Current vs. Luminous Flux

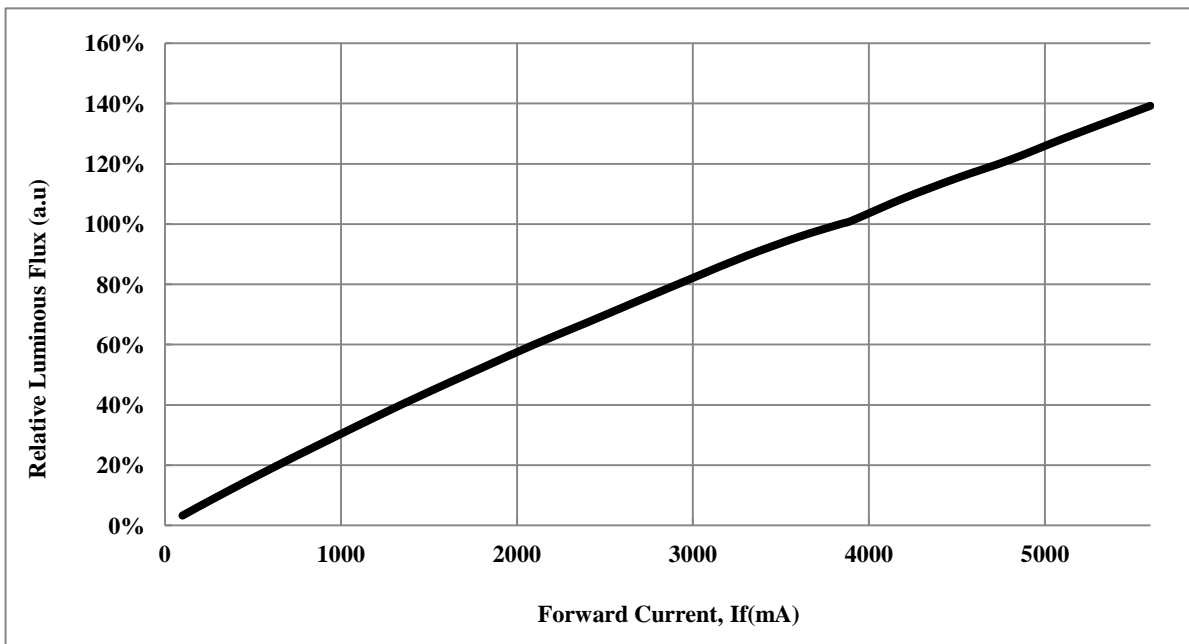

(5) Solder Temperature vs. Luminous Flux

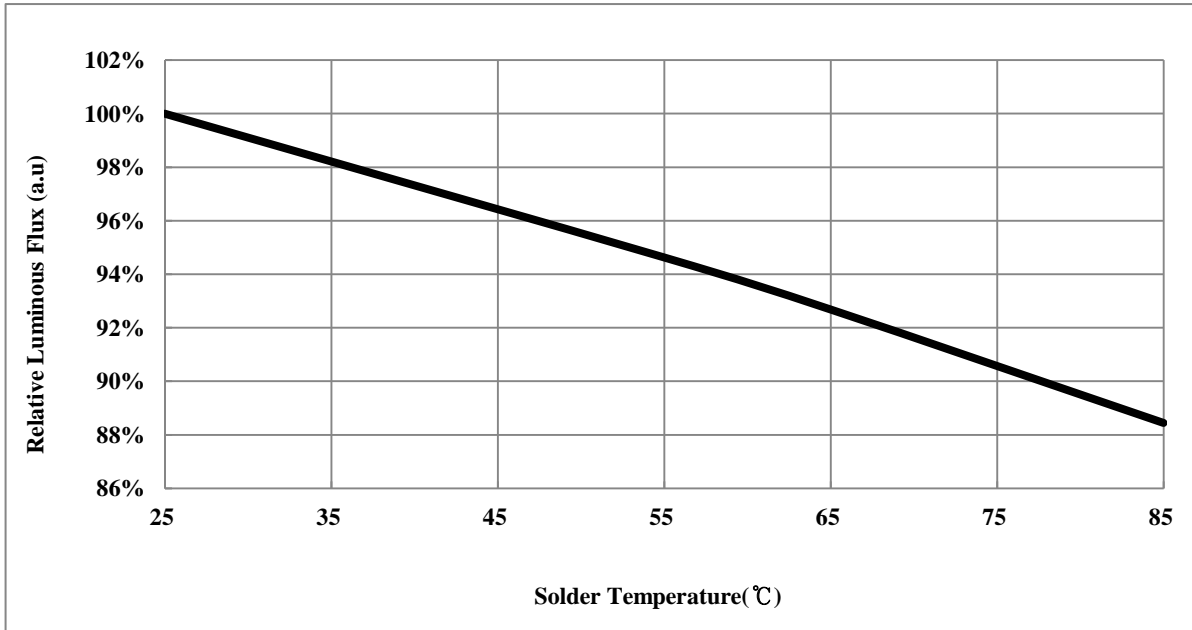

(6) Solder Temperature vs. Forward Voltage

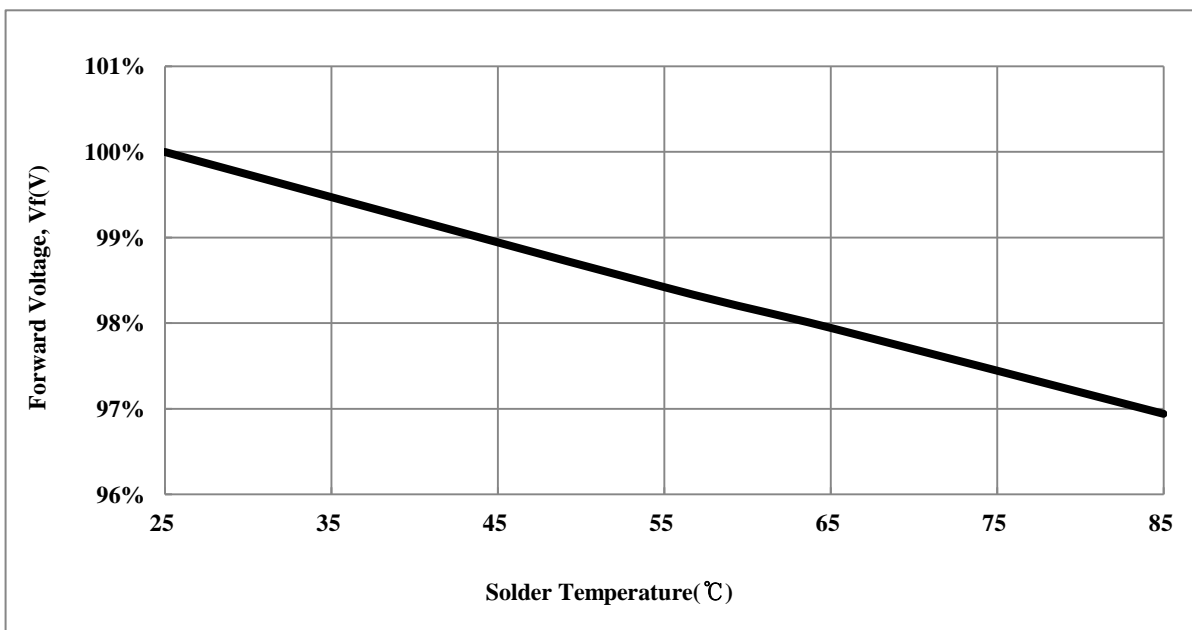

(7) Forward Current vs. Chromaticity

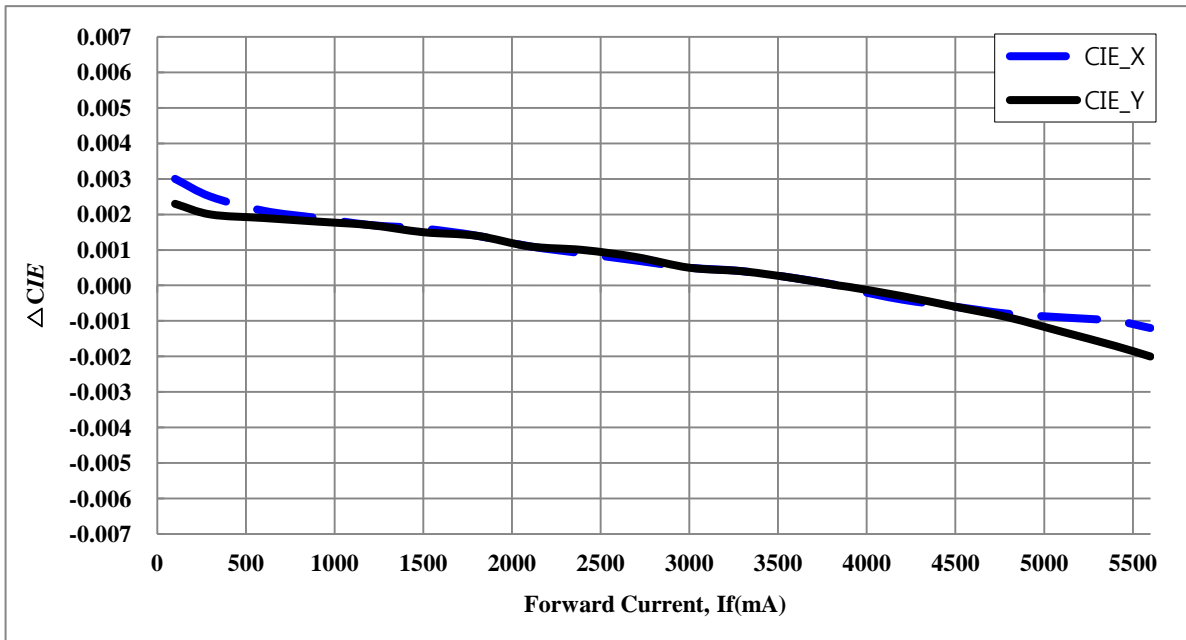

(8) Solder Temperature vs. Chromaticity

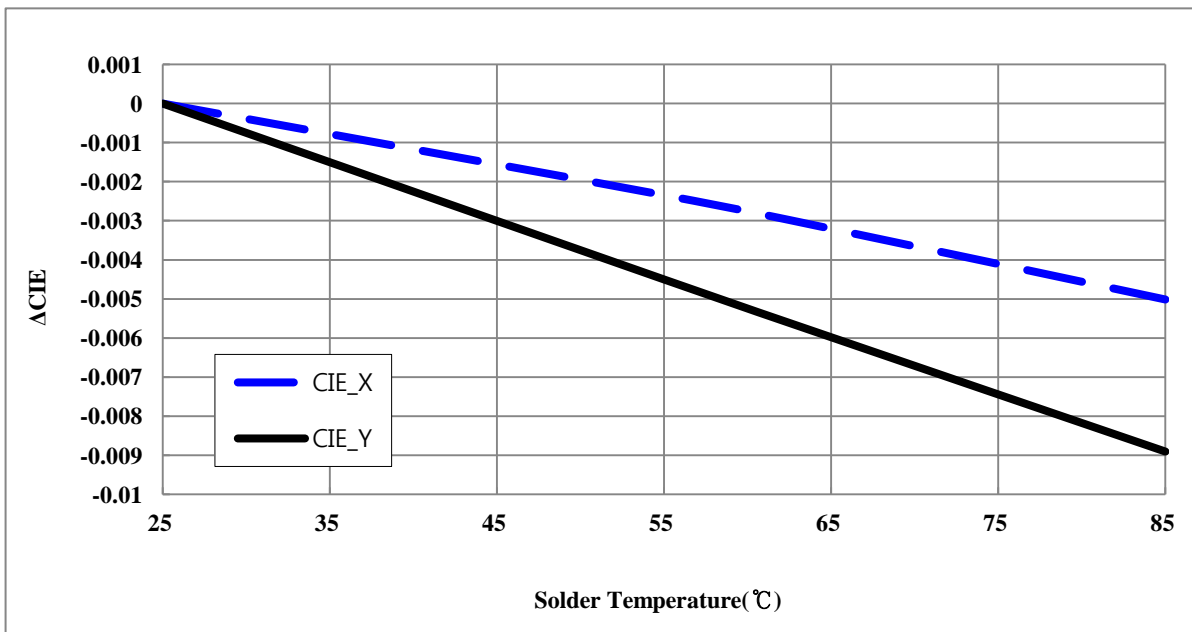

(9) Ambient Temperature vs. Maximum Current

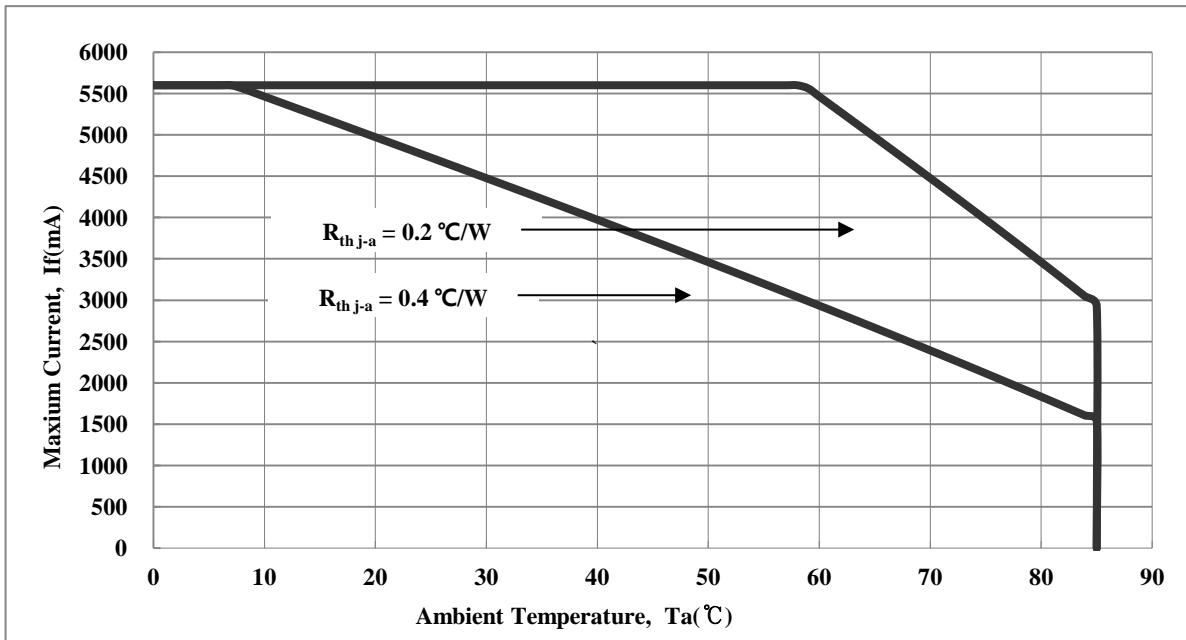

6. Results of Reliability Test

(1) Test Items and Results

Item	Test Condition	Operating Current	Notes
Temperature Cycle	-40℃ ~25℃ ~100℃ ~25℃ (30min~5min~30min~5min)	-	200 Cycles
Steady State Operating Life	T _s = 55℃	3840mA	1000hrs
Steady State Operating Life of High Temperature 1	T _s = 85℃	3840mA	1000hrs
Steady State Operating Life of High Temperature 2	T _s = 95℃	3840mA	1000hrs
Steady State Operating Life of High Humidity Heat	T _a = 85℃, RH = 85%	3840mA	1000hrs
Steady State Operating Life of Low Temperature	T _a = -40℃	3840mA	1000hrs
On/Off Test	T _a = 25℃, 30 sec On - 30 Sec Off	3840mA	20,000 Cycles
Moisture Sensitivity Levels	T _a = 30℃, RH = 60% 192hr → Reflow 260℃ 3 Time	-	-

(2) Criteria for Judging the Damage

Parameter	Symbol	Condition	Criteria for Judgement	
			Min.	Max.
Forward Voltage	V _F	IF =3840mA	-	U.S.L. ⁽¹⁾ * 1.2
Luminous Flux	ΦV	IF =3840mA	L.S.L. ⁽²⁾ * 0.9	-

* U.S.L. : Upper Specification Level

* L.S.L. : Lower Specification Level

7. Precaution for Use

(1) Static Electricity

These LEDs are highly susceptible to static electricity or surge voltage. So a wrist strap or an anti-electrostatic glove necessarily be used when handling the LEDs. Do not use the equipment that surge voltage is came into existence.

All devices and equipment that measure or mount the LEDs must be properly grounded.

After being assembled LEDs, it should be ascertained a electrical characteristic whether that are damaged by static electricity or not. It is easy to find the damaged LEDs by a light-on or VF test at forward a below 0.15mA current.

(2) Packing

The moisture that is absorbed into the LED products may cause a badness and damage to the optical characteristics of the LEDs. Therefore the moisture barrier aluminum bag is used to keep moisture in the packing. And a silicagel is inserted into a moisture barrier aluminum bag that sealed by the thermal pressure sealer.

(3) Cleaning

We greatly recommend IPA(solution) for LED cleaning and it should be limited exposure time for cleaning maximum 1 minute. (We can not guarantee the quality assurance if it has been used to other solution.)

It is recommended that isopropyl alcohol(IPA) be used as a solvent for cleaning the LEDs.

Do not clean the LEDs by the ultrasonic. When it use other solvents or is absolutely necessary ultrasonic, before cleaning, a pre-test should be done to confirm whether the LEDs are any damaged or not

(4) Storage

In order to avoid the absorption of moisture, it is recommended to store LEDs in the moisture barrier aluminum bag is not opened.

Storage condition before opening the packing :

Temperature : below 30°C Humidity : 90%RH max

The LEDs should be used within a year.

Storage condition after opening the packing :

Temperature : below 30°C Humidity : 60%RH max

The products have to be used within one year from the date marked on label which is attached to reel or aluminium bag.

After opening the packing, the LEDs should be used within 168 hours(7days). If unused LEDs remain, they should be stored in the place kept away moisture.

If the LEDs have exceeded the above storage time, it should be used after to bake using the following conditions.

Baking condition : 60±5°C, more than 24 hours

(5) Pick and Place

It should be avoided to rub or scratch the surface of resin by any hard material. It is possible that the LEDs are damaged to the optical characteristics.

(6) Heat

The LEDs are products that are generated heat. Please consider the heat generation of the LED when it is designed the PCB. After considering the ambient temperature and the heat generation of LEDs, the operating current should be decided

(7) Others

If the forward or reverse voltage which exceeds the absolute maximum rating is applied to the LEDs, that will cause the damage to the LEDs. It is possible that the damaged LEDs do not light on at the low current.

Be careful not to look the LEDs that the output power is strongly increased in the face. It is possible that eyesight has been getting weaker.

This specifications of the product may be revised without notice.

Light emitting part should not be exposed by physical contact. It can be the reason of material desquamation and progressive disconnection.

This LED is made for in-door use only. If the user wants the LED for out-door use, it is necessary to take some additional treatment on the product after surface mounting technology(SMT).

This specification could be changed without a notice to the customer because of the inside circumstance of the company.